

Wellbore Diagrams

"Fluid conditioning systems"

Odessa Separator Inc.

Maximizing production performance with
integrated artificial lift solutions.

OSI Glossary

Filtration / Sand Control

TS: Tubing Screen
SP: Super Perf
PG: Pump Guard
BV: Bypass Valve

Gas separation

SGS: Slotted Gas Shield
GS: Gas Shield
GSS: Gas & Sand Shield
SGSS: Super Gas & Sand Shield
DBSGSS: Dual body Super Gas & Sand Shield

Chemical Treatment

CS: Chemical Screen
EXT.CS: Extended Chemical Screen

Components

BP: Bull Plug
MJ: Mud Joint
TC: Tubing Connection
NFN: No-Flow Nipple
FN: Flow Nipple
SN: Seating Nipple
DT: Dip Tube
CR: Collar
COC: Change Over Collar

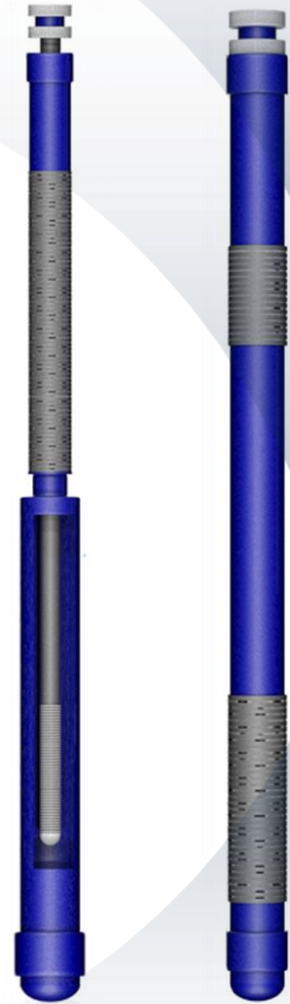

Configuration

Pump type

- PCP
- Gas lift
- Jet pump
- ESP
- Flowing
- Rod Pump
- Hydraulic pump

Dip-Tube

- 48 Ft
- 68 Ft
- 110 Ft

Gas Separation

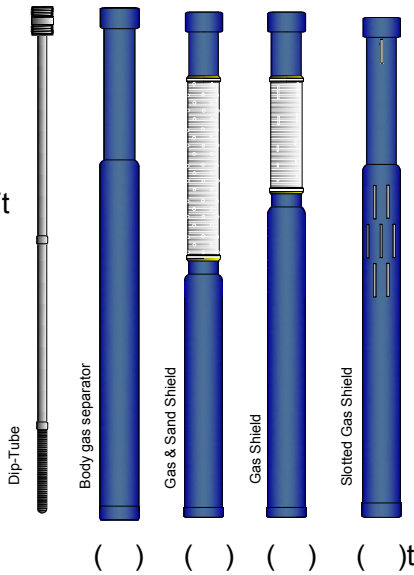

Filtration / Sand Control

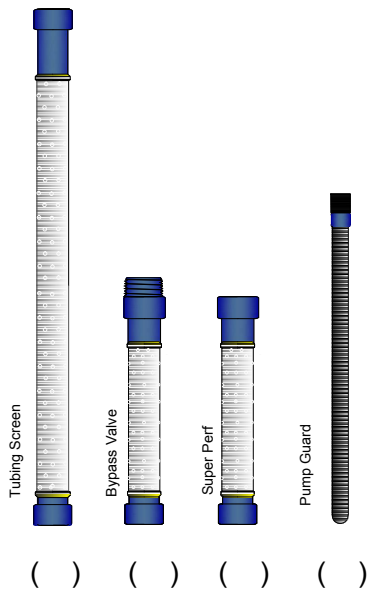

Chemical Tools

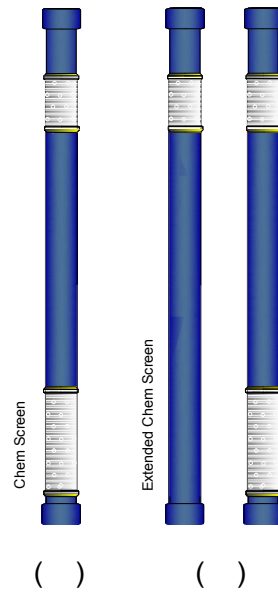

Components

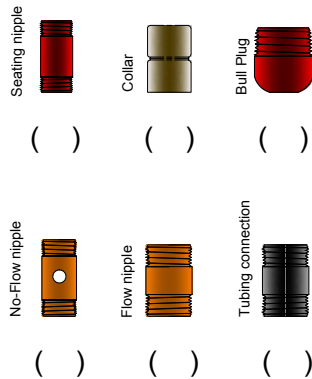

Chemical Treatment

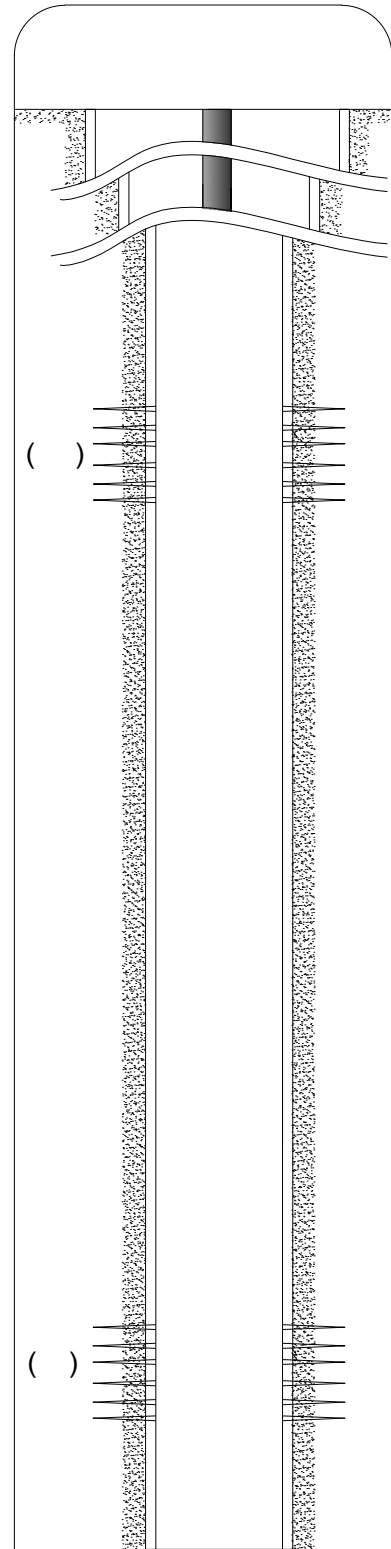
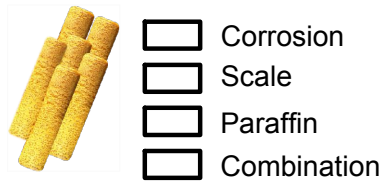

Company:
Field:
Well:

Config. 0.0 / Make your own well configuration



Phone: +1 (432) 580-7111
Fax: +1 (432) 333-2015
1612 Viceroy • Odessa, TX 79763, US
ggonzalez@odessaseparator.com

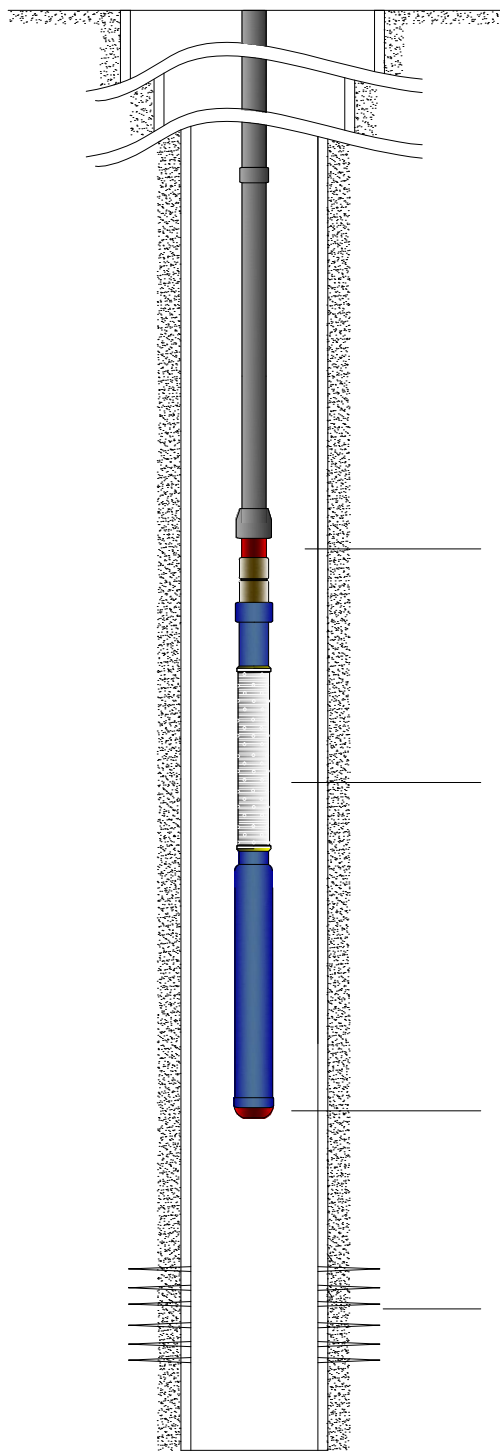

Seating nipple

Gas & Sand Shield

OSI Bull Plug

Perfs

Joint tubing

Seating nipple

Collar

Dip-Tube

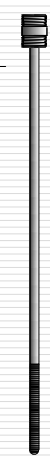
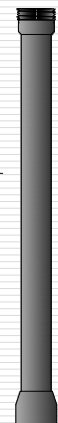

Company:
Field:
Well:

Config. 1.1 / Gas & Sand Shield - Bull Plug



Phone: +1 (432) 580-7111
Fax: +1 (432) 333-2015
1612 Viceroy • Odessa, TX 79763, US
ggonzalez@odessaseparator.com

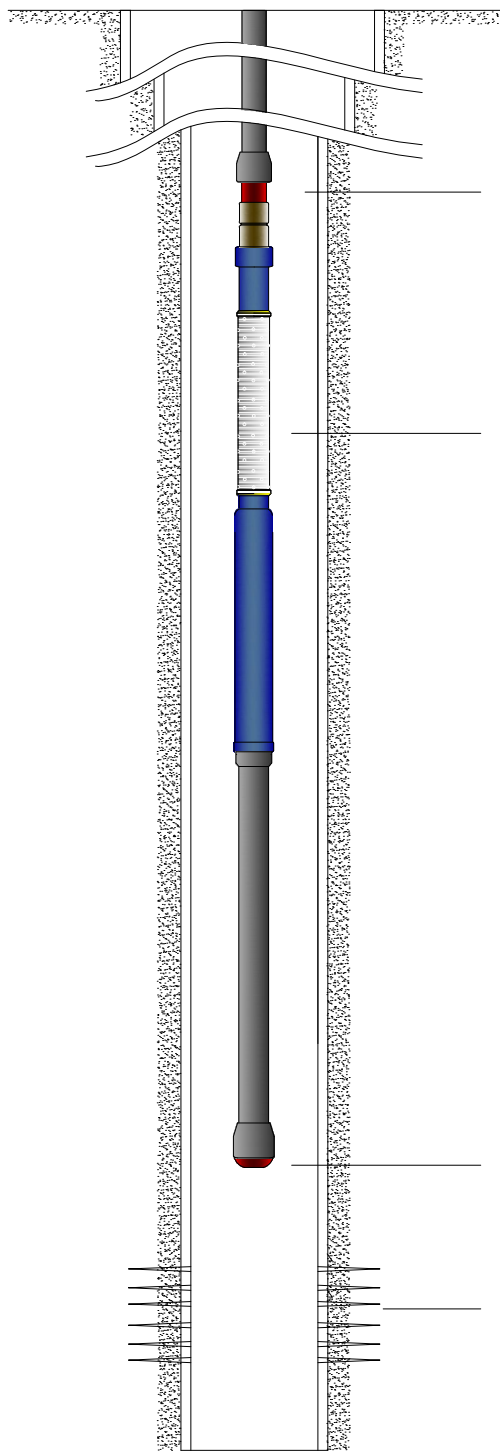

Seating nipple

Gas & Sand Shield

OSI Bull Plug

Perfs

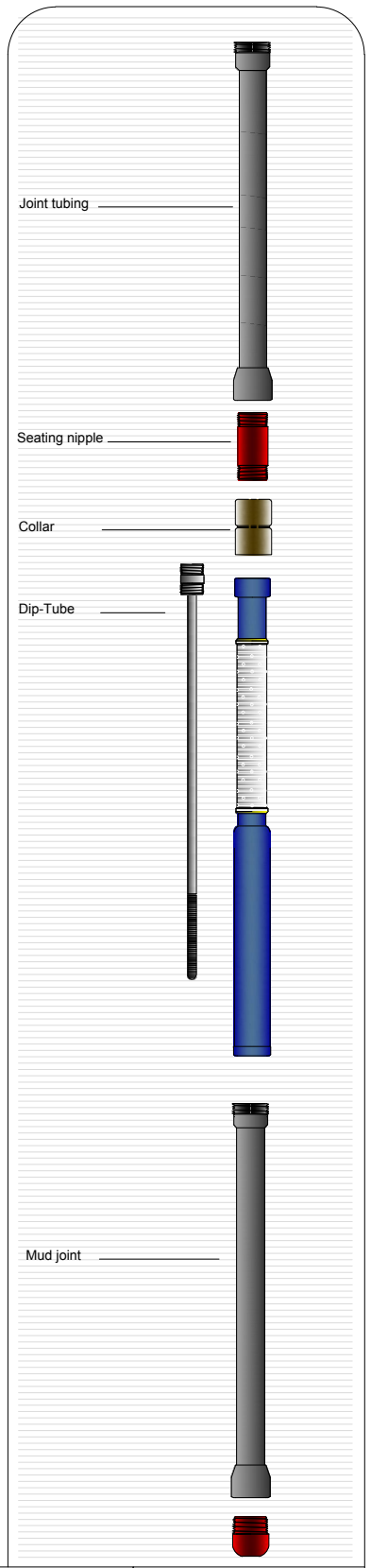

Joint tubing

Seating nipple

Collar

Dip-Tube

Mud joint

Company:
Field:
Well:

Config. 1.2 / Gas & Sand Shield - Mud joint - Bull Plug



Phone: +1 (432) 580-7111
Fax: +1 (432) 333-2015
1612 Viceroy • Odessa, TX 79763, US
ggonzalez@odessaseparator.com

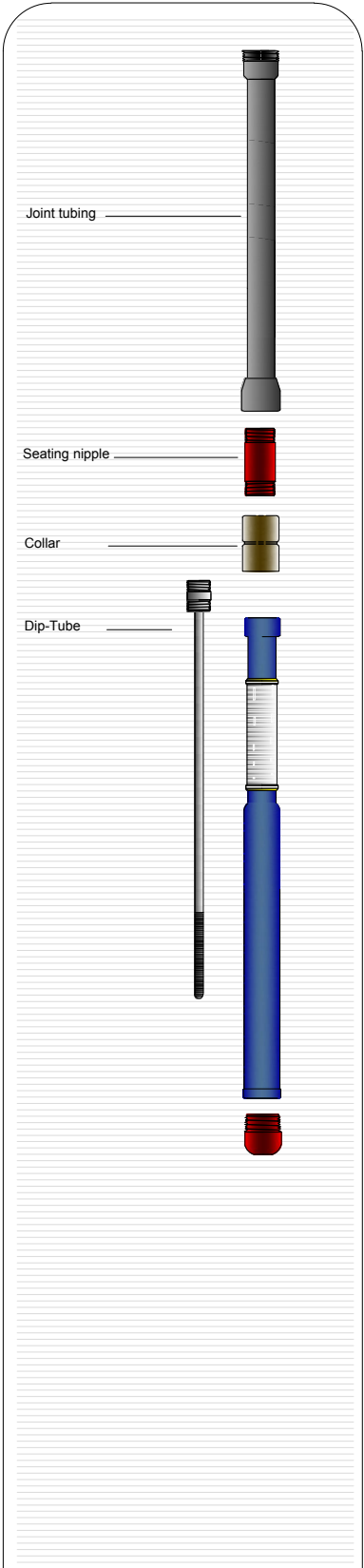
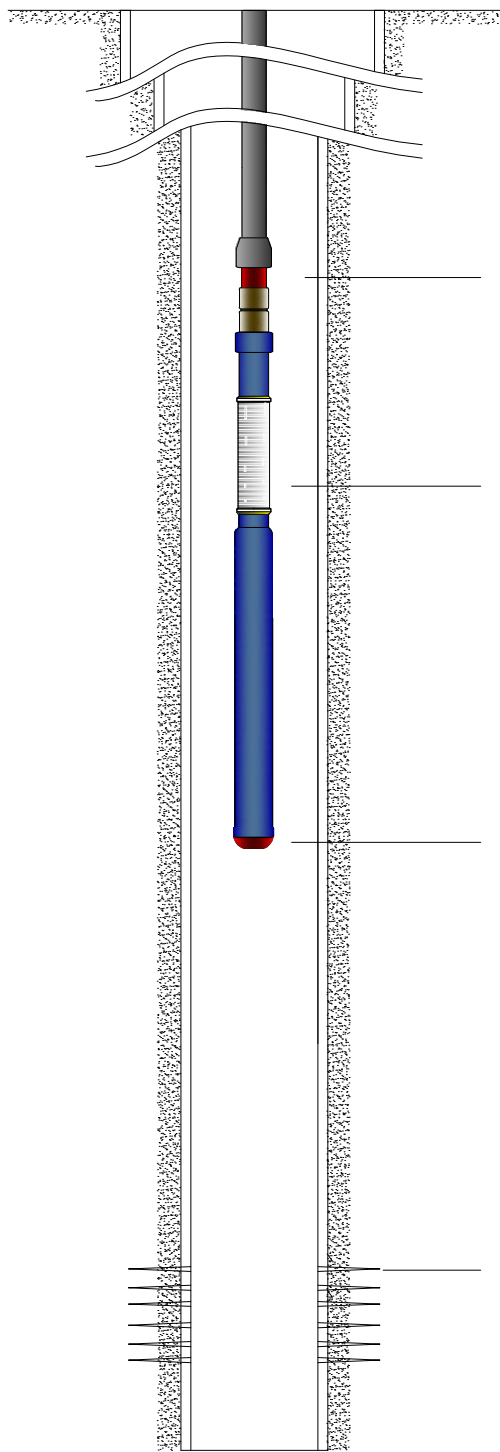

Company:
 Field:
 Well:

Config. 2.1 / Gas Shield - Bull Plug

ODESSA
SEPARATOR, INC.

Phone: +1 (432) 580-7111
 Fax: +1 (432) 333-2015
 1612 Viceroy • Odessa, TX 79763, US
 ggonzalez@odessaseparator.com

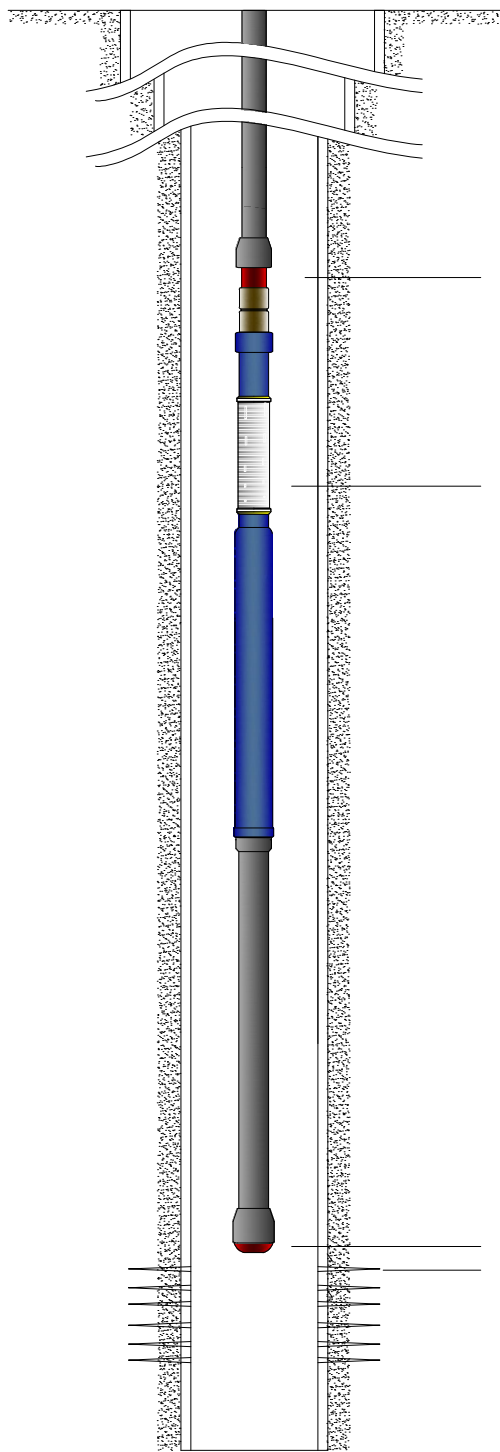

Seating nipple

Gas Shield

OSI Bull Plug
Perfs

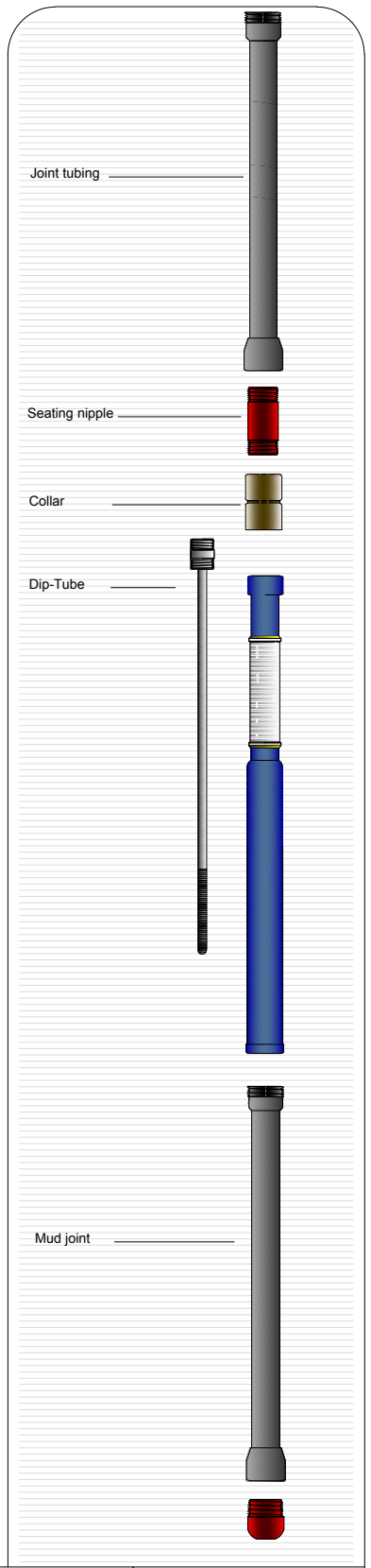

Joint tubing

Seating nipple

Collar

Dip-Tube

Mud joint

Company:
Field:
Well:

Config. 2.2 / Gas Shield - Mud joint - Bull Plug



Phone: +1 (432) 580-7111
Fax: +1 (432) 333-2015
1612 Viceroy • Odessa, TX 79763, US
ggonzalez@odessaseparator.com

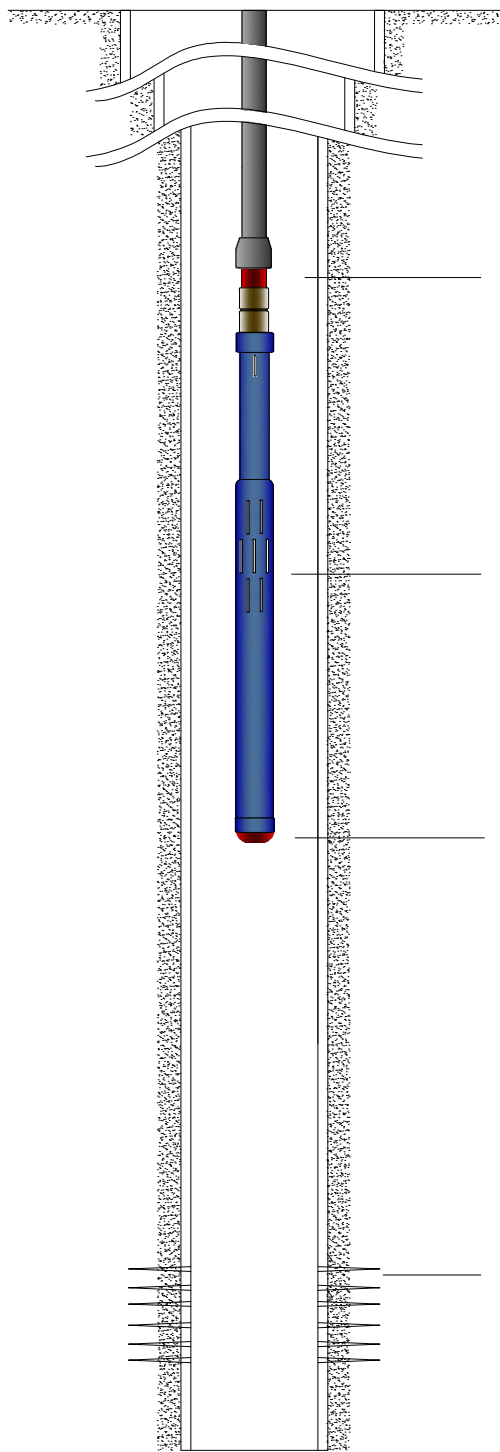

Seating nipple

Slotted Gas Shield

OSI Bull Plug

Perfs

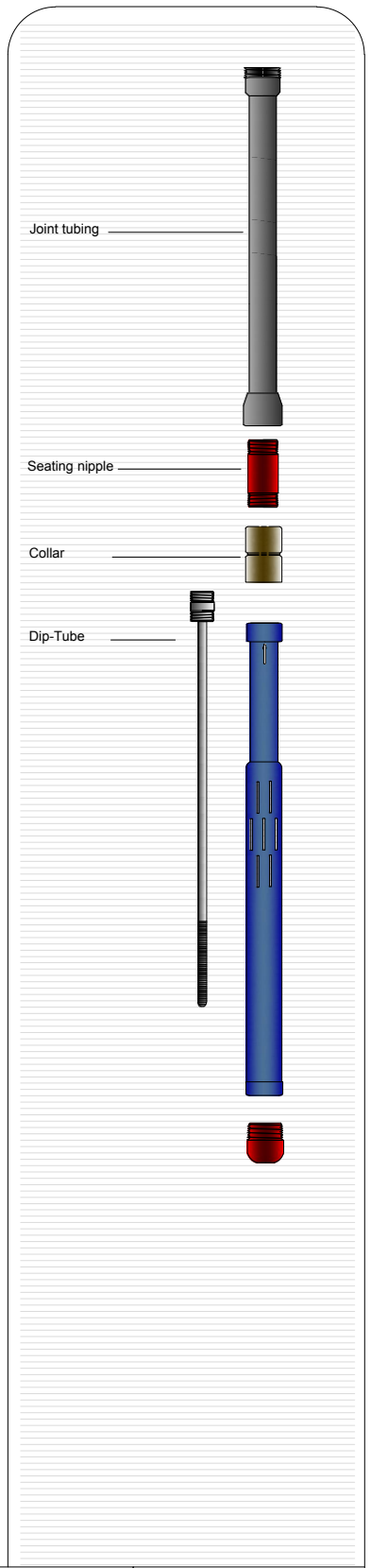

Joint tubing

Seating nipple

Collar

Dip-Tube

Company:
 Field:
 Well:

Config. 3.1 / Slotted Gas Shield - Bull Plug

Phone: +1 (432) 580-7111
 Fax: +1 (432) 333-2015
 1612 Viceroy • Odessa, TX 79763, US
 ggonzalez@odessaseparator.com

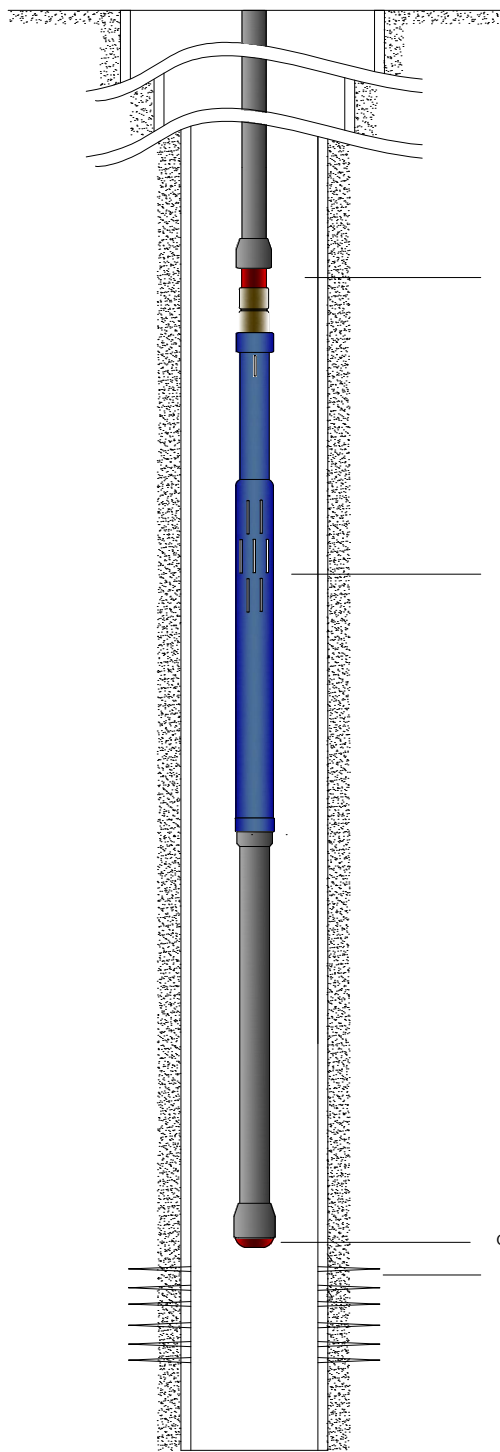

Seating nipple

Slotted Gas Shield

OSI Bull Plug

Perfs

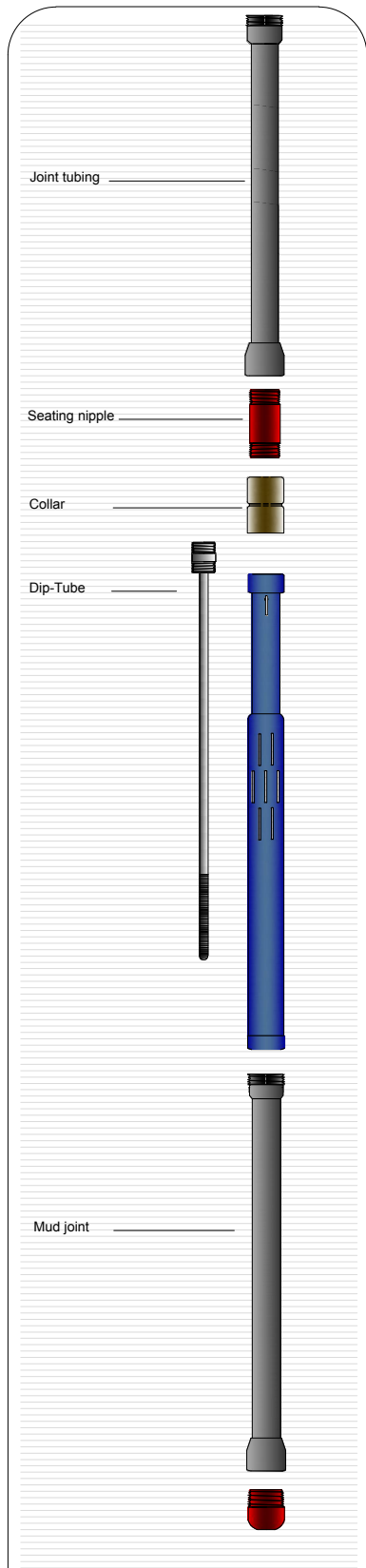

Joint tubing

Seating nipple

Collar

Dip-Tube

Mud joint

Company:
 Field:
 Well:

Config. 3.2 / Slotted Gas Shield - Mud joint - Bull Plug

ODESSA
SEPARATOR, INC.

Phone: +1 (432) 580-7111
 Fax: +1 (432) 333-2015
 1612 Viceroy • Odessa, TX 79763, US
 ggonzalez@odessaseparator.com

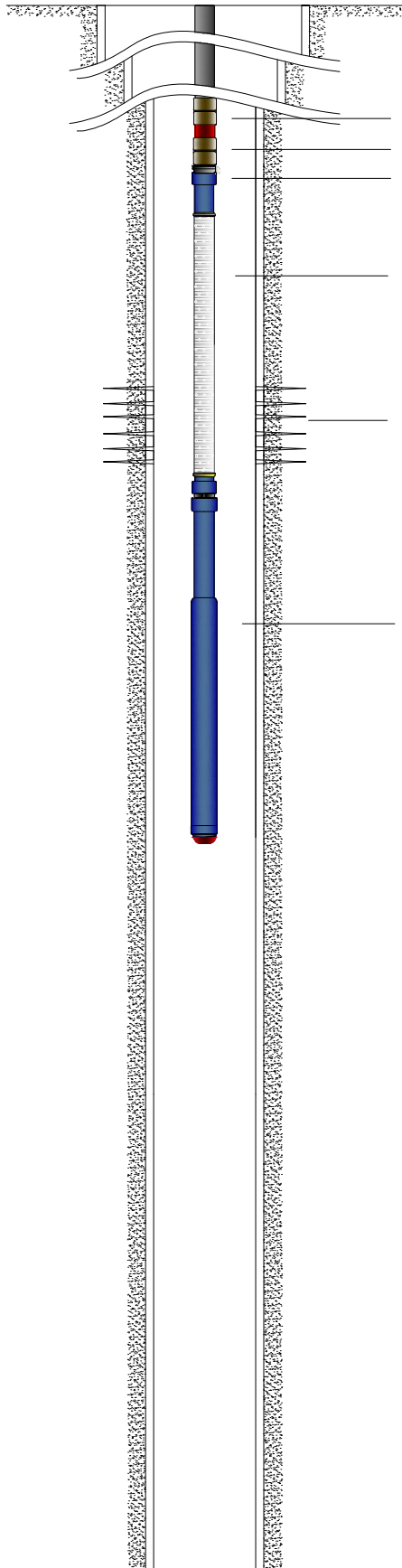

Collar
 Seating nipple
 Collar
 Tubing Screen
 Perfs
 Body

Super Gas & Sand Shield

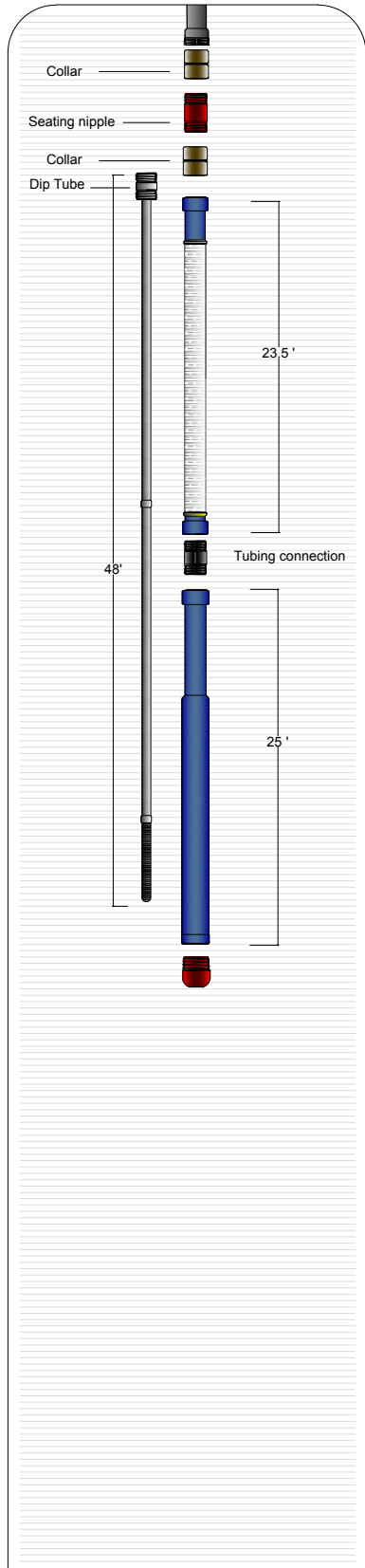

Collar
 Seating nipple
 Collar
 Dip Tube
 48'

23.5'
 Tubing connection
 25'

Company:
 Field:
 Well:

Config. 4.1 / Super Gas & Sand Shield with 48 ft - Bull Plug

Phone: +1 (432) 580-7111
 Fax: +1 (432) 333-2015
 1612 Viceroy • Odessa, TX 79763, US
 ggonzalez@odessaseparator.com

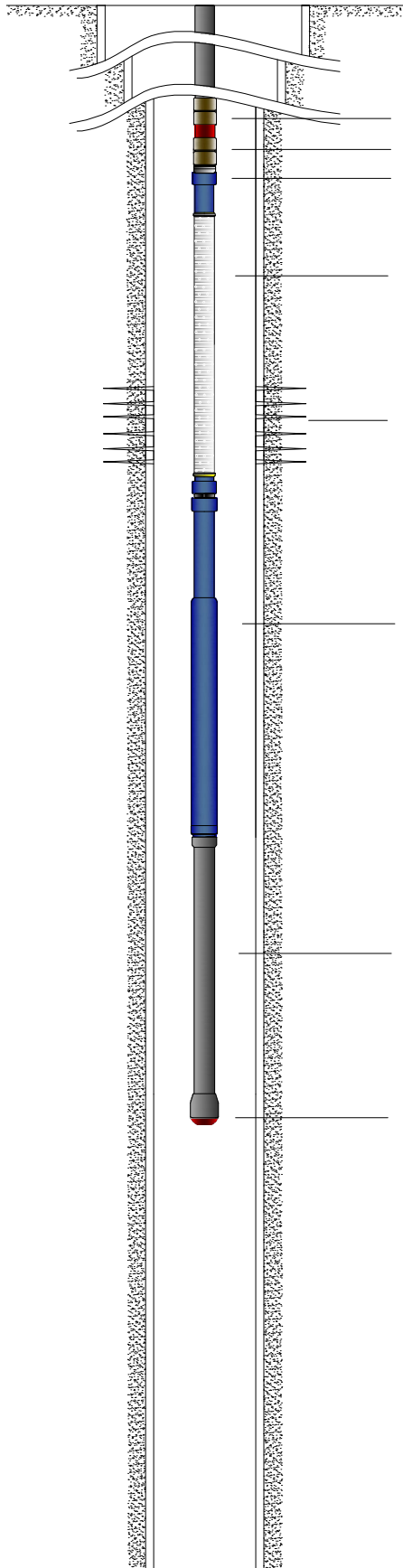

Collar

Seating nipple

Collar

Tubing Screen

Perfs

Super Gas & Sand Shield

Body

Mud joint

OSI Bull Plug

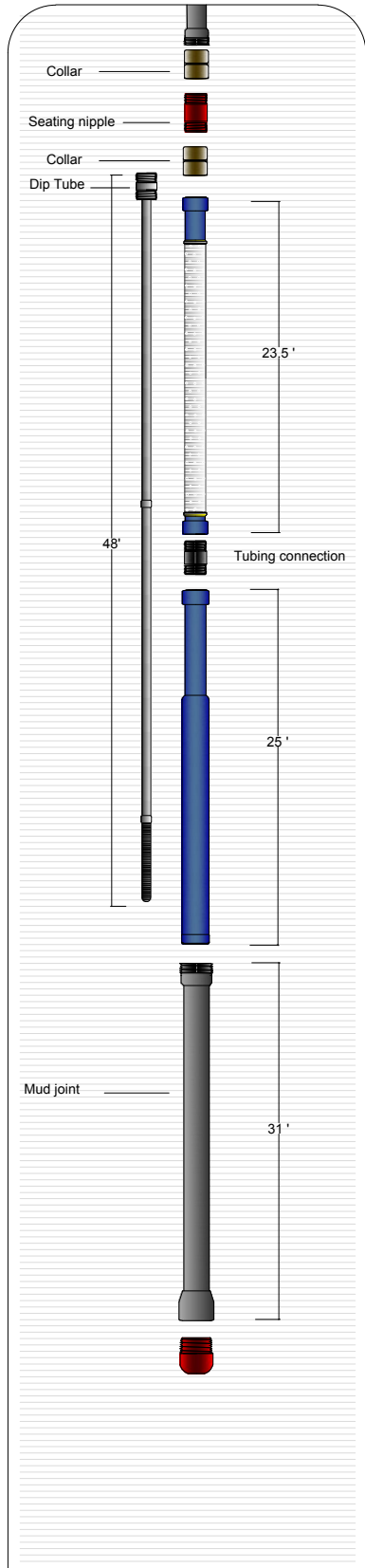

Collar

Seating nipple

Collar

Dip Tube

23.5'

48'

Tubing connection

25'

Mud joint

31'

Company:
Field:
Well:

Config. 4.2 / Super Gas & Sand Shield with 48 ft - Mud joint - Bull Plug



Phone: +1 (432) 580-7111
Fax: +1 (432) 333-2015
1612 Viceroy • Odessa, TX 79763, US
ggonzalez@odessaseparator.com

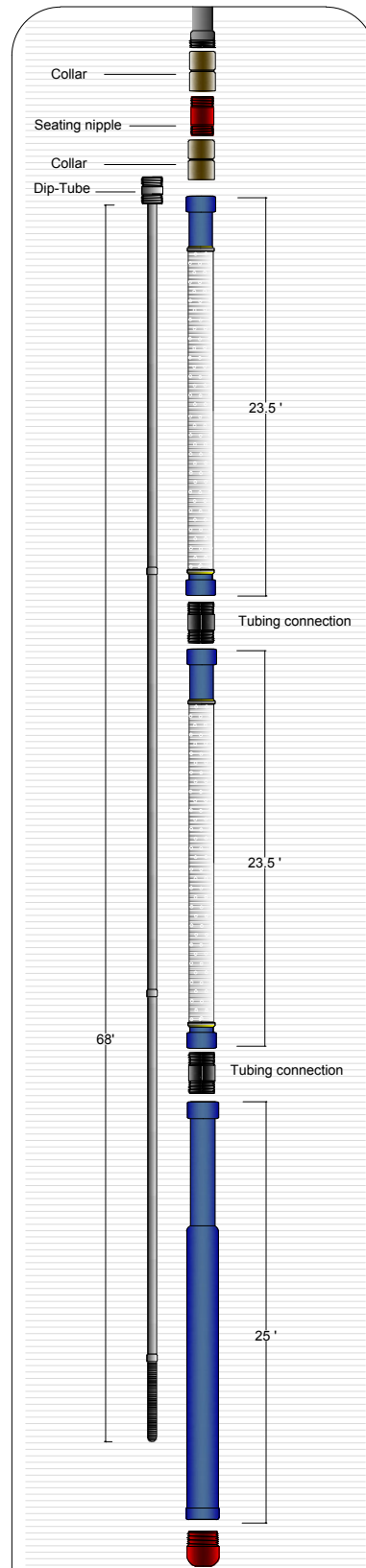
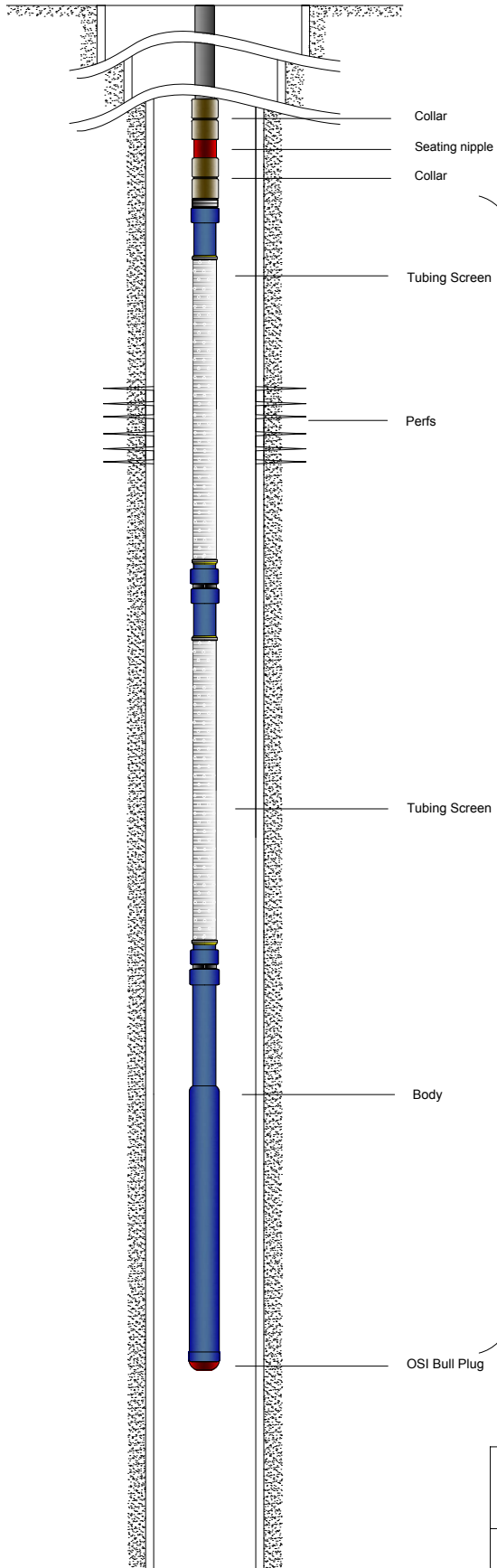

Company:
Field:
Well:

Config. 4.3 / Super Gas & Sand Shield with 68 ft - Bull Plug



Phone: +1 (432) 580-7111
Fax: +1 (432) 333-2015
1612 Viceroy • Odessa, TX 79763, US
ggonzalez@odessaseparator.com

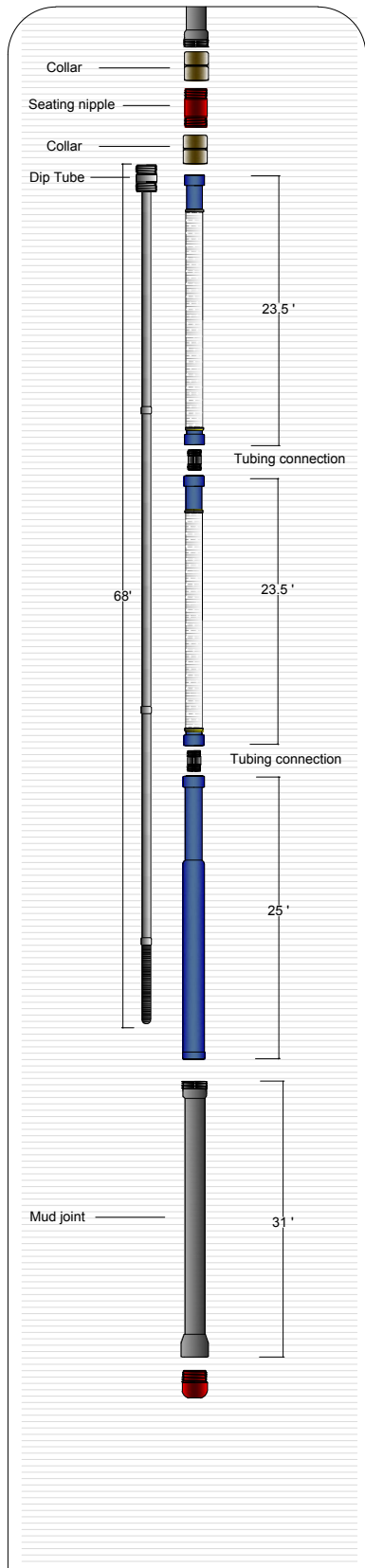
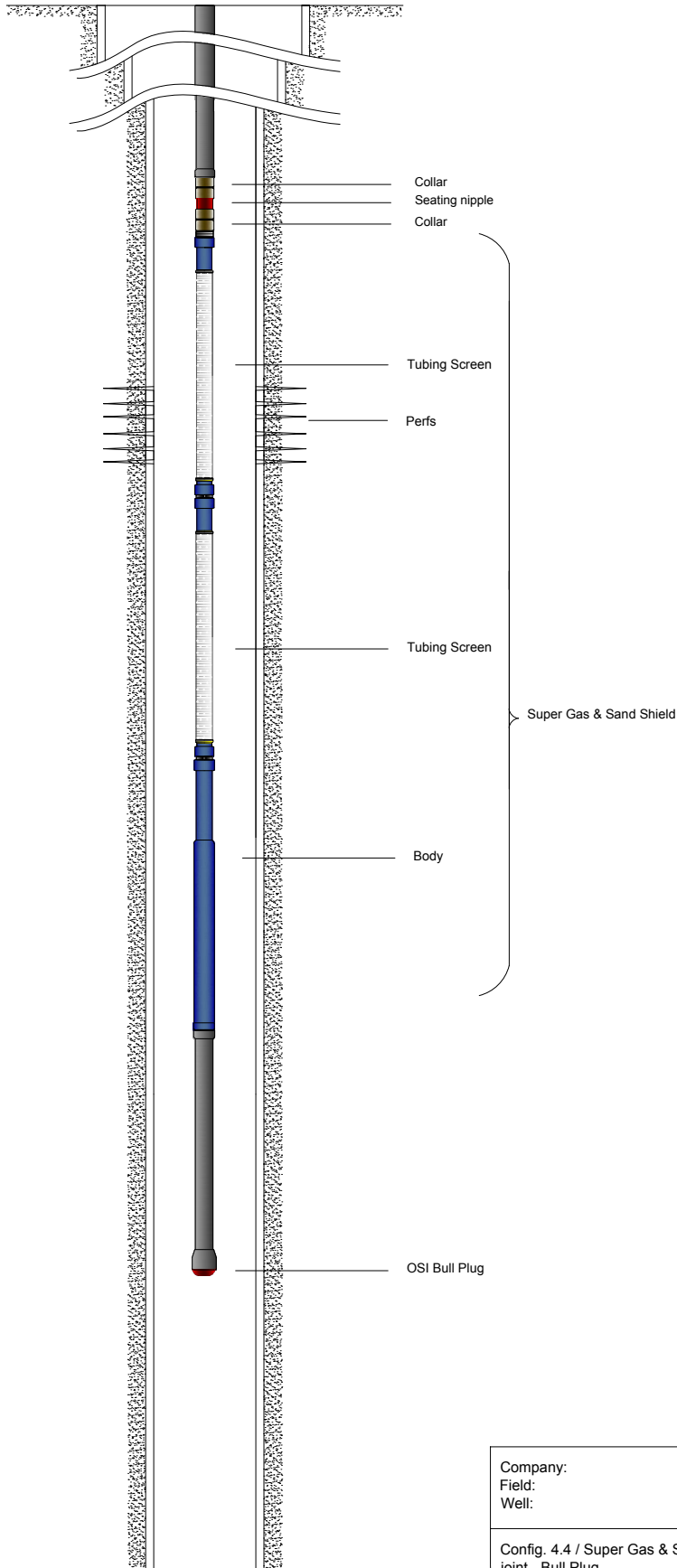

Company:
Field:
Well:

Config. 4.4 / Super Gas & Sand Shield with 68 ft - Mud joint - Bull Plug

ODESSA
SEPARATOR, INC.

Phone: +1 (432) 580-7111
Fax: +1 (432) 333-2015
1612 Viceroy • Odessa, TX 79763, US
ggonzalez@odessaseparator.com

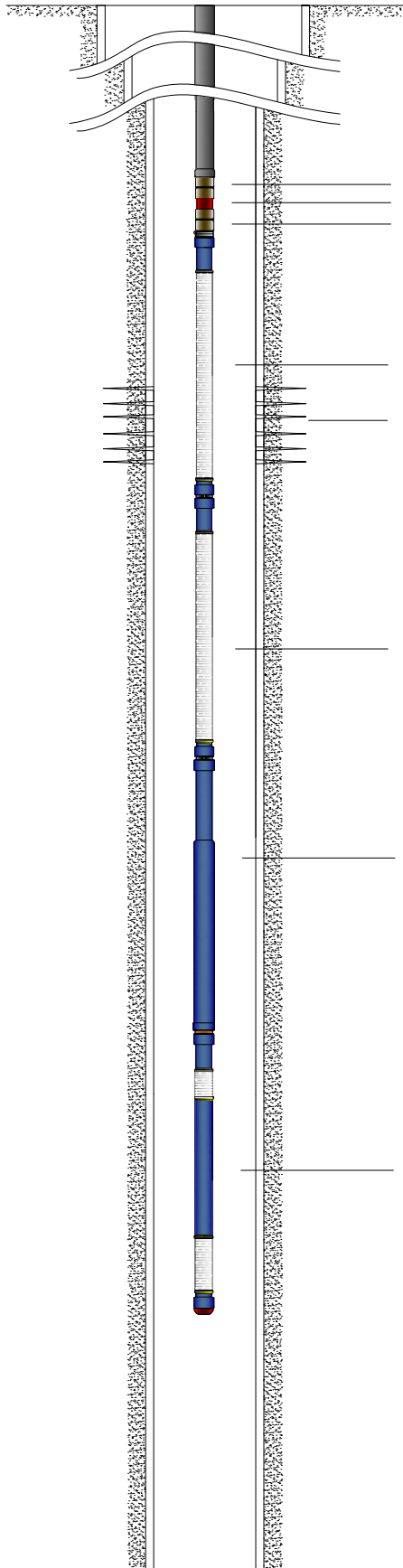

Collar
Seating nipple
Collar

Tubing Screen
Perfs

Tubing Screen

Super Gas & Sand Shield

Body

Chem Screen

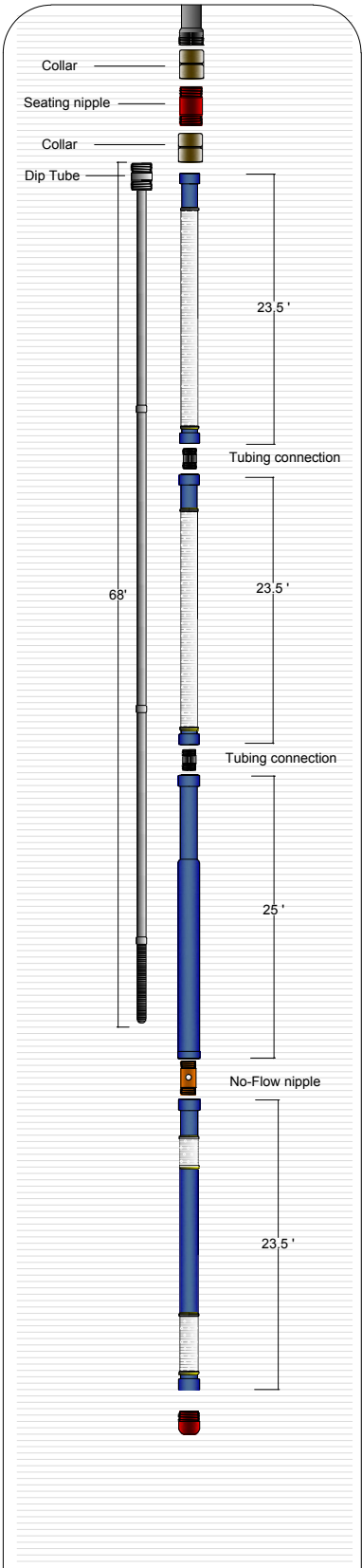

Company:
Field:
Well:

Config. 4.5 / Super Gas & Sand Shield with 68 ft - Chem Screen - Bull Plug

Phone: +1 (432) 580-7111
Fax: +1 (432) 333-2015
1612 Viceroy • Odessa, TX 79763, US
ggonzalez@odessaseparator.com

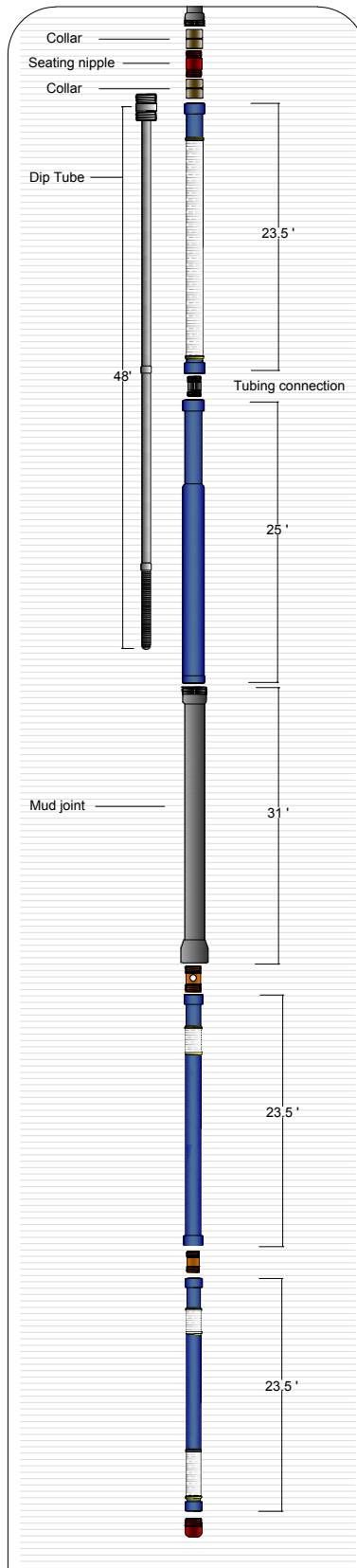
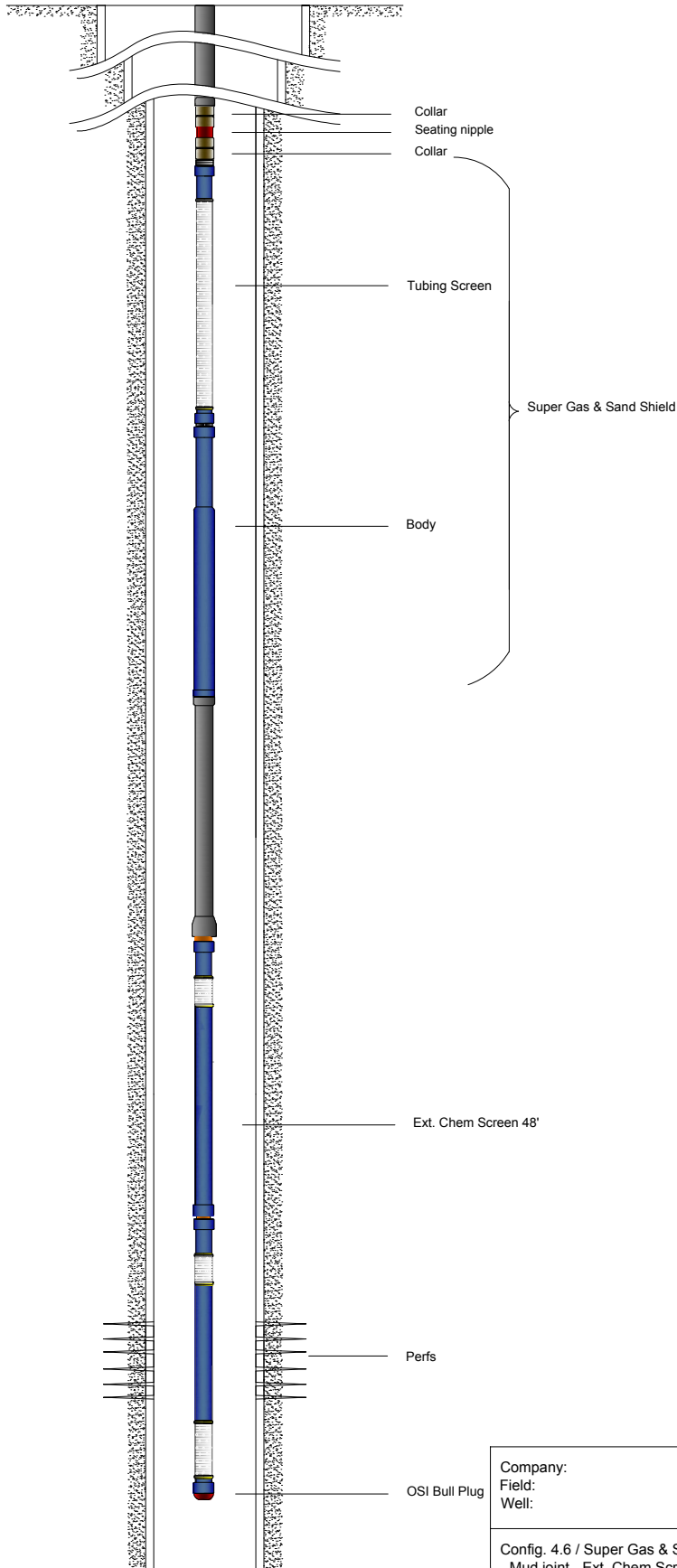

Company:
Field:
Well:

Config. 4.6 / Super Gas & Sand Shield with Dip-Tube 48 ft
- Mud joint - Ext. Chem Screen-Bull Plug

ODESSA
SEPARATOR, INC.

Phone: +1 (432) 580-7111
Fax: +1 (432) 333-2015
1612 Viceroy • Odessa, TX 79763, US
ggonzalez@odessaseparator.com

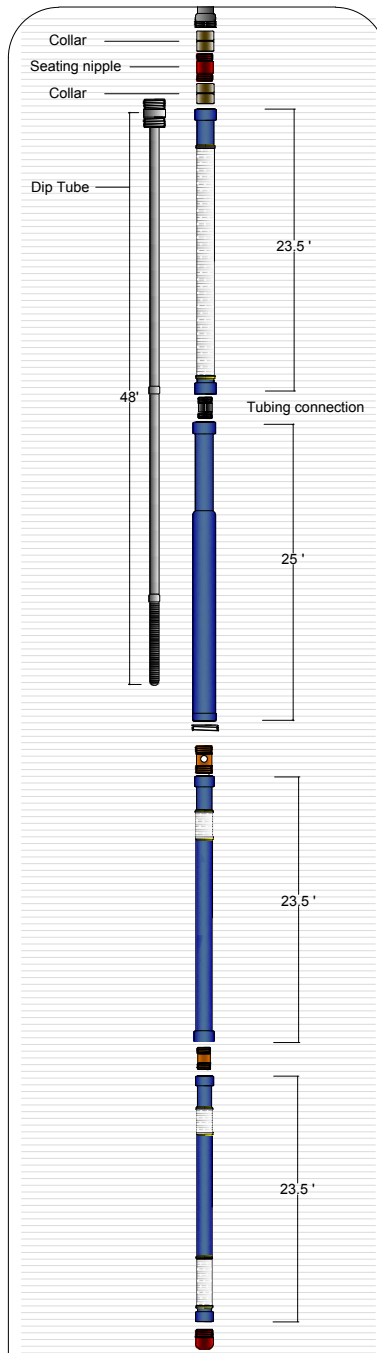
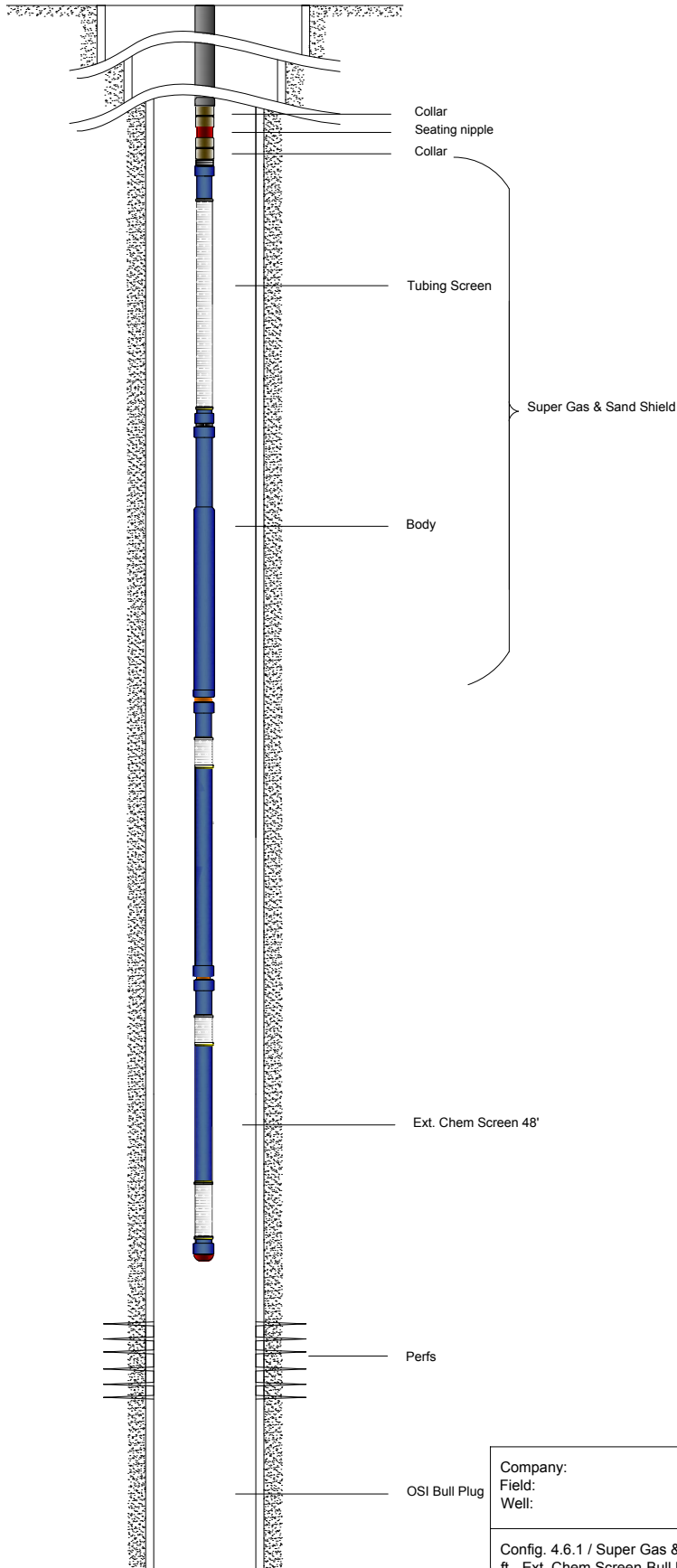

Company:
Field:
Well:

Config. 4.6.1 / Super Gas & Sand Shield with Dip-Tube 48 ft - Ext. Chem Screen-Bull Plug

Phone: +1 (432) 580-7111
Fax: +1 (432) 333-2015
1612 Viceroy • Odessa, TX 79763, US
ggonzalez@odessaseparator.com

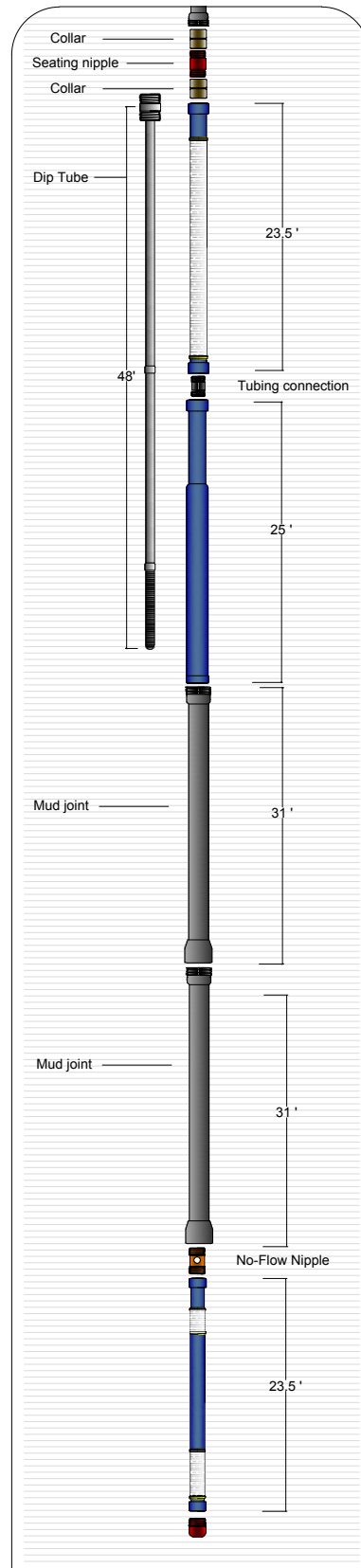
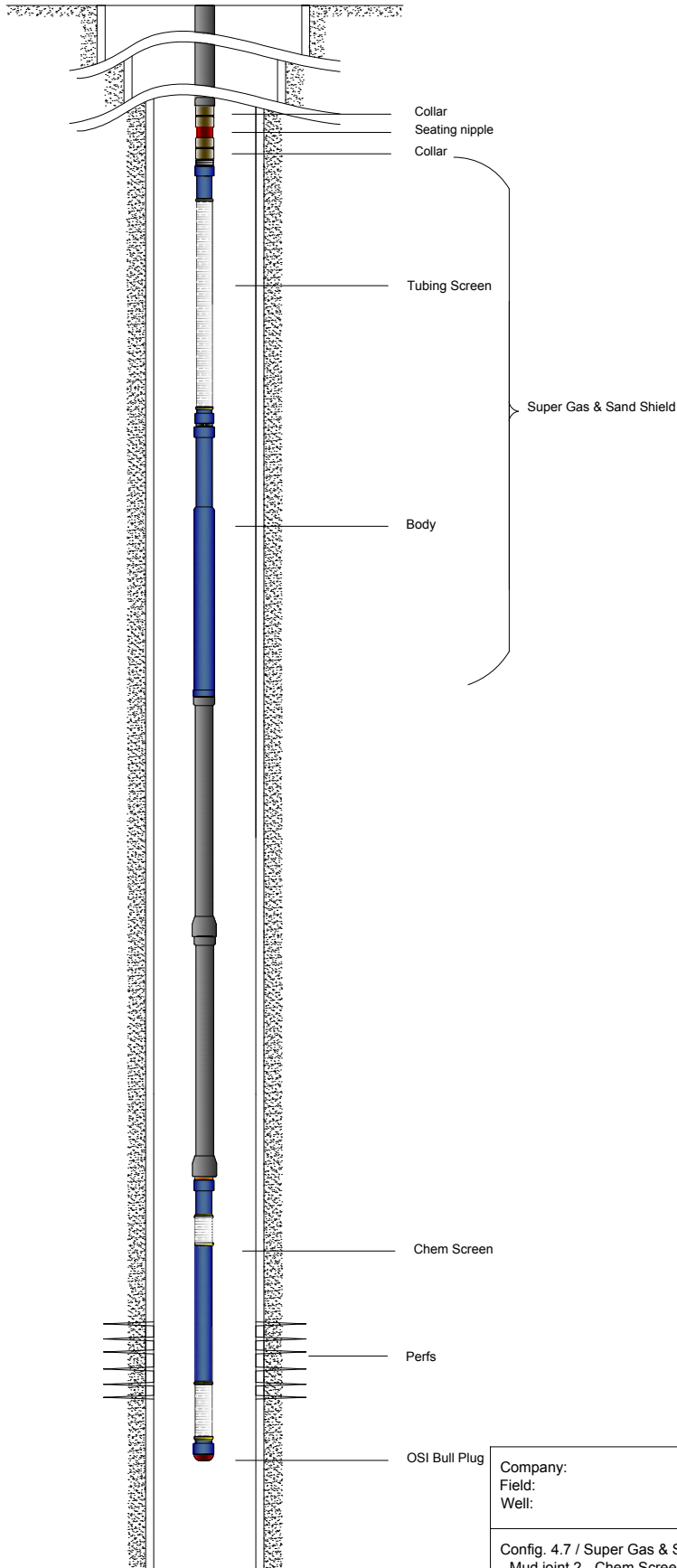

Company:
Field:
Well:

Config. 4.7 / Super Gas & Sand Shield with Dip-Tube 48 ft
- Mud joint 2 - Chem Screen-Bull Plug



Phone: +1 (432) 580-7111
Fax: +1 (432) 333-2015
1612 Viceroy • Odessa, TX 79763, US
ggonzalez@odessaseparator.com

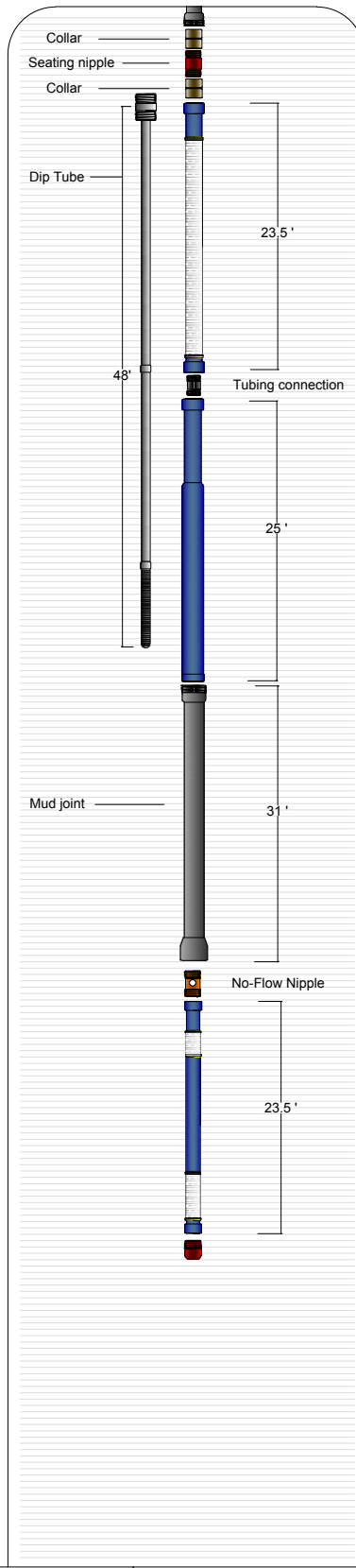
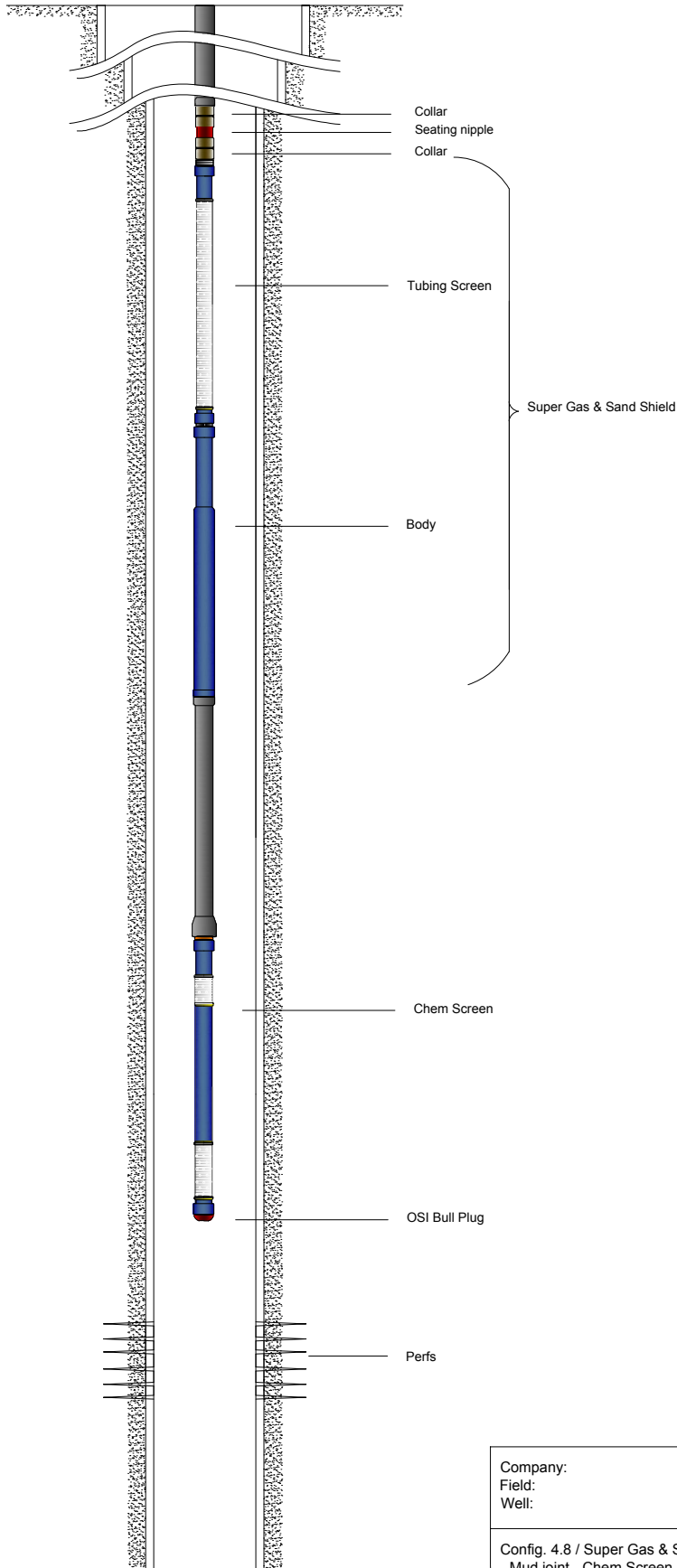

Company:
 Field:
 Well:

Config. 4.8 / Super Gas & Sand Shield with Dip-Tube 48 ft
 - Mud joint - Chem Screen-Bull Plug

Phone: +1 (432) 580-7111
 Fax: +1 (432) 333-2015
 1612 Viceroy • Odessa, TX 79763, US
 ggonzalez@odessaseparator.com

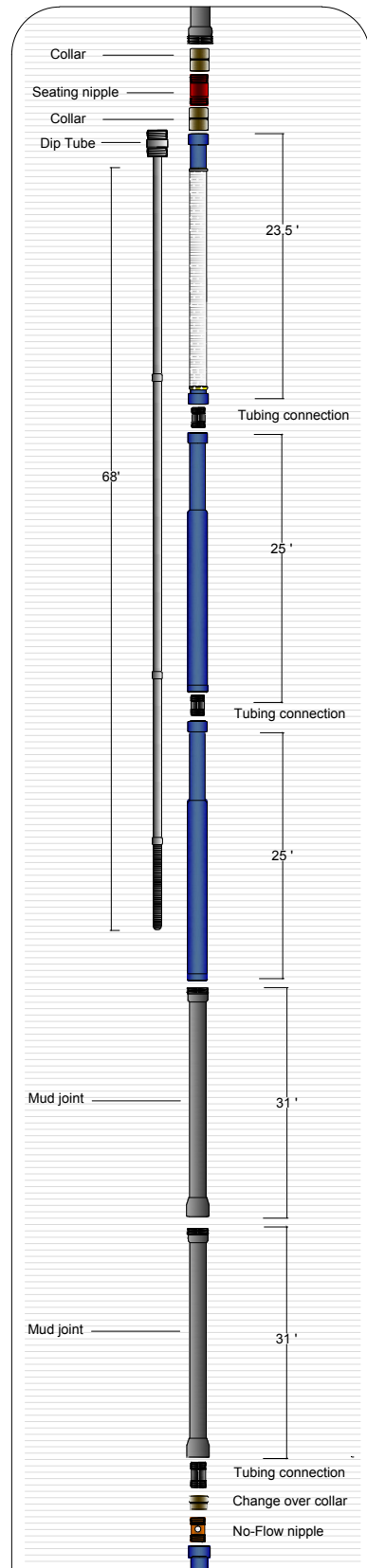
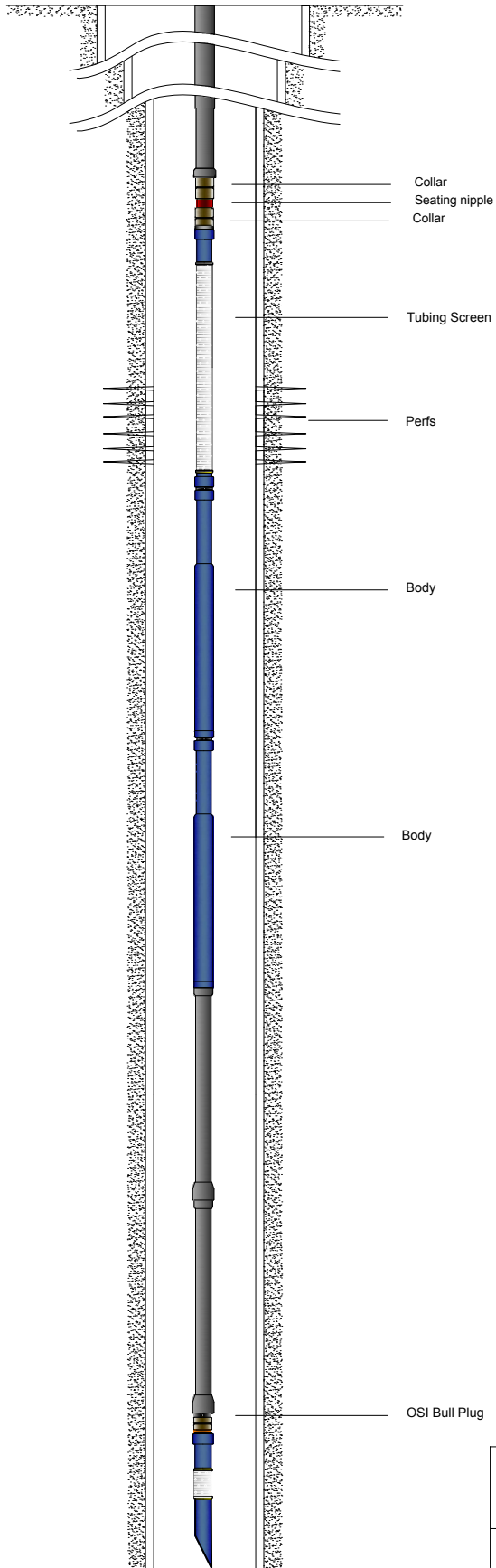

Company:
Field:
Well:

Config. 4.9.1 / Super Gas & Sand Shield with 68' Dip-Tube
- 2 Mud joint - Chem Screen - Bull Plug



Phone: +1 (432) 580-7111
Fax: +1 (432) 333-2015
1612 Viceroy • Odessa, TX 79763, US
ggonzalez@odessaseparator.com

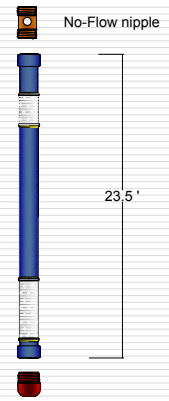
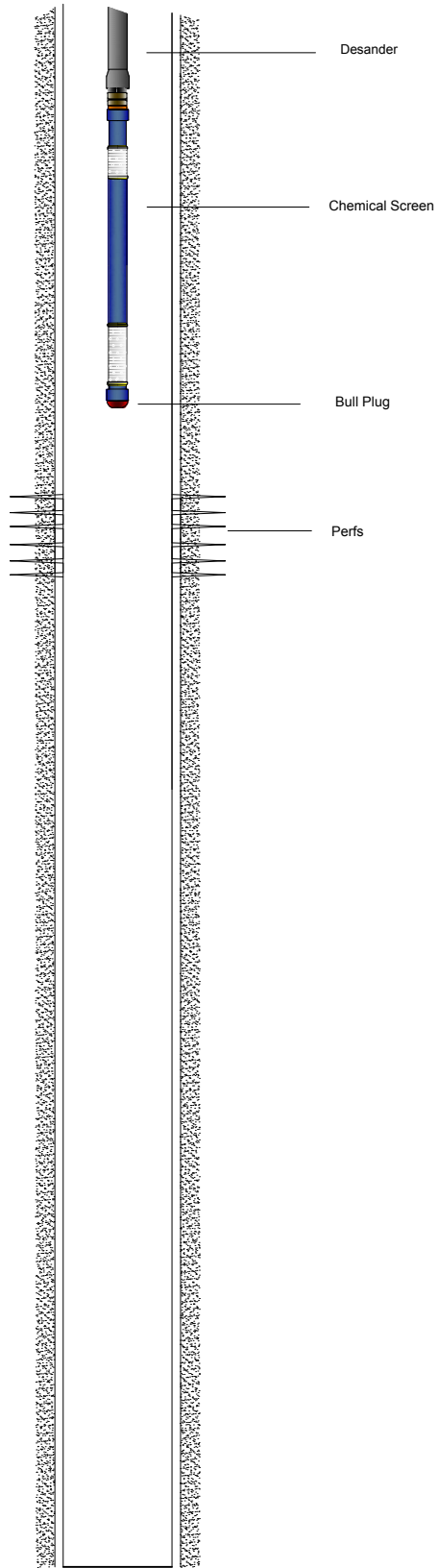

Company:
Field:
Well:

Config. 4.9.2 / Super Gas & Sand Shield with 68' Dip-Tube
- 2 Mud joint - Chem Screen - Bull Plug



Phone: +1 (432) 580-7111
Fax: +1 (432) 333-2015
1612 Viceroy • Odessa, TX 79763, US
ggonzalez@odessaseparator.com

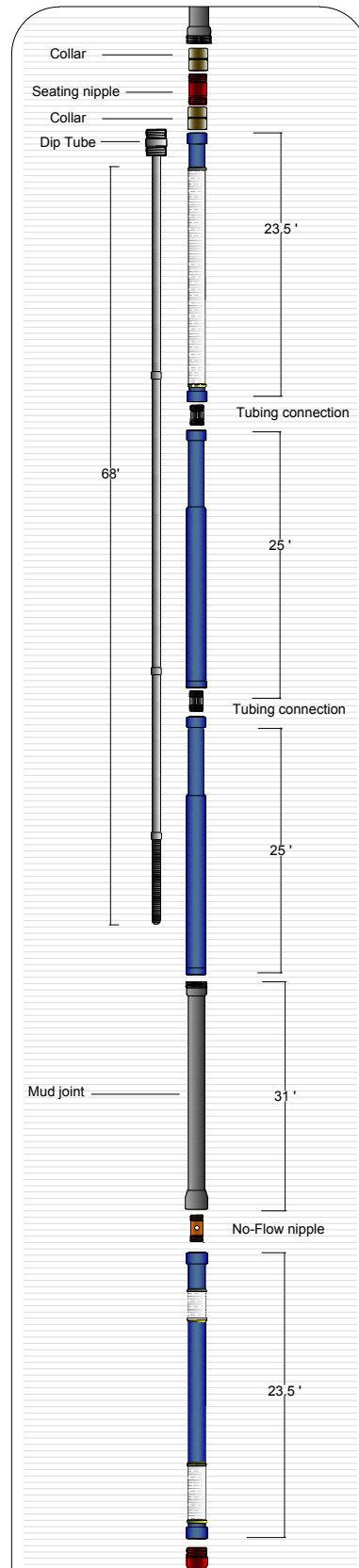
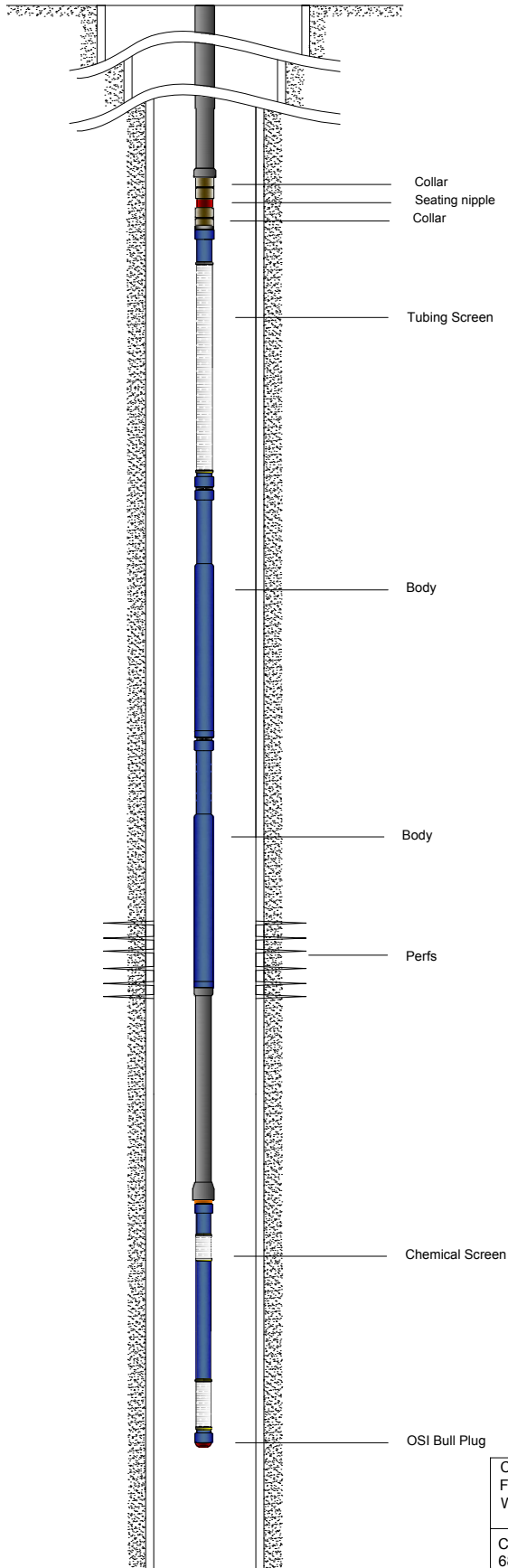

Company:
Field:
Well:

Config. 4.10 / Dual Body Super Gas & Sand Shield with
68' Dip-Tube - Mud joint - Chem Screen - Bull Plug



Phone: +1 (432) 580-7111
Fax: +1 (432) 333-2015
1612 Viceroy • Odessa, TX 79763, US
ggonzalez@odsep.com

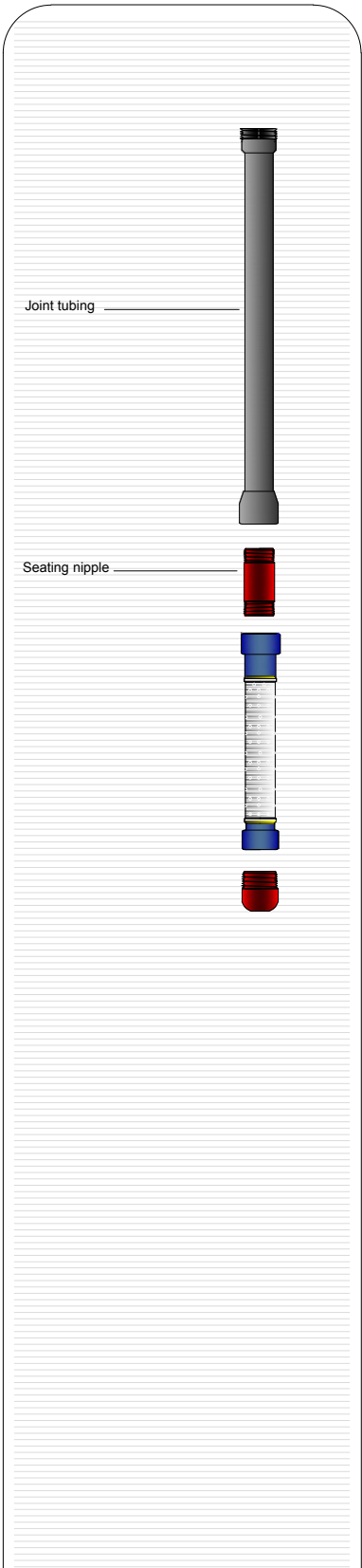
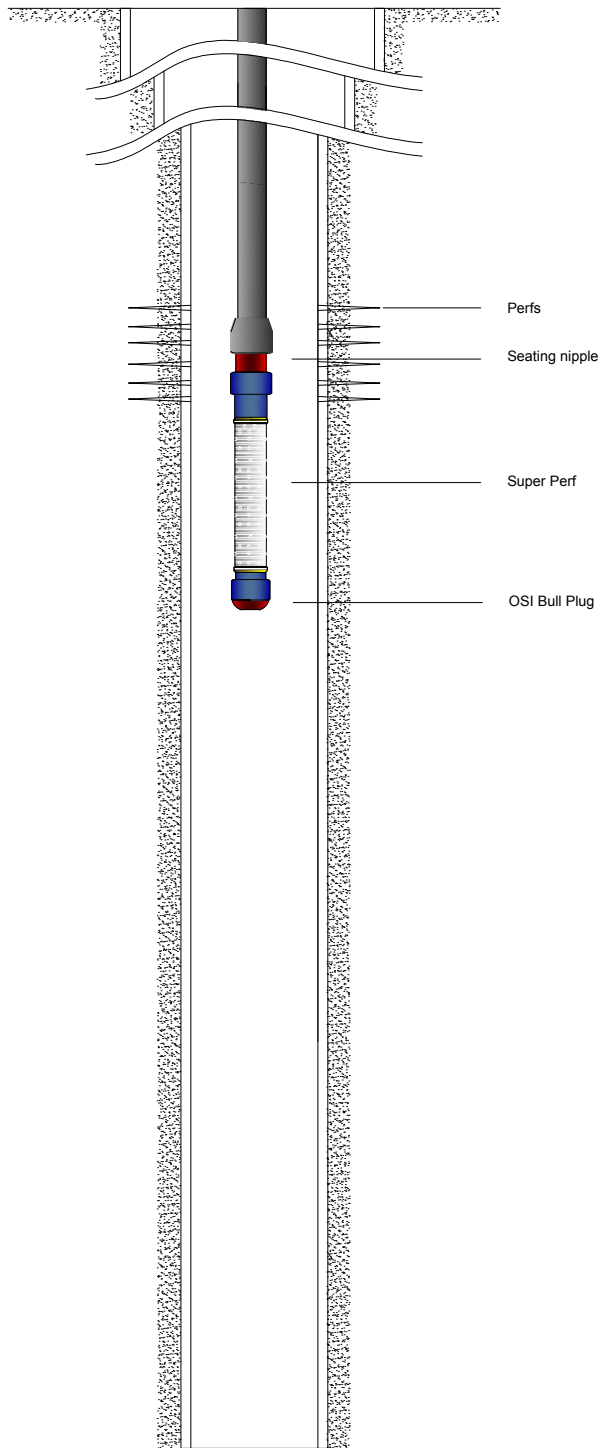

Company:
Field:
Well:

Config. 5.1 / Super Perf - Bull Plug



Phone: +1 (432) 580-7111
Fax: +1 (432) 333-2015
1612 Viceroy • Odessa, TX 79763, US
ggonzalez@odessaseparator.com

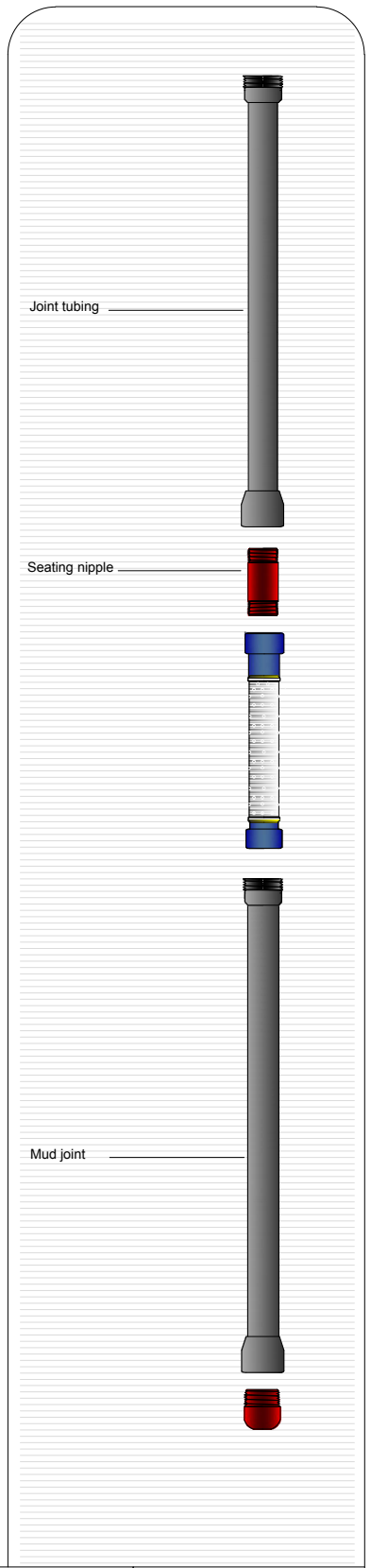
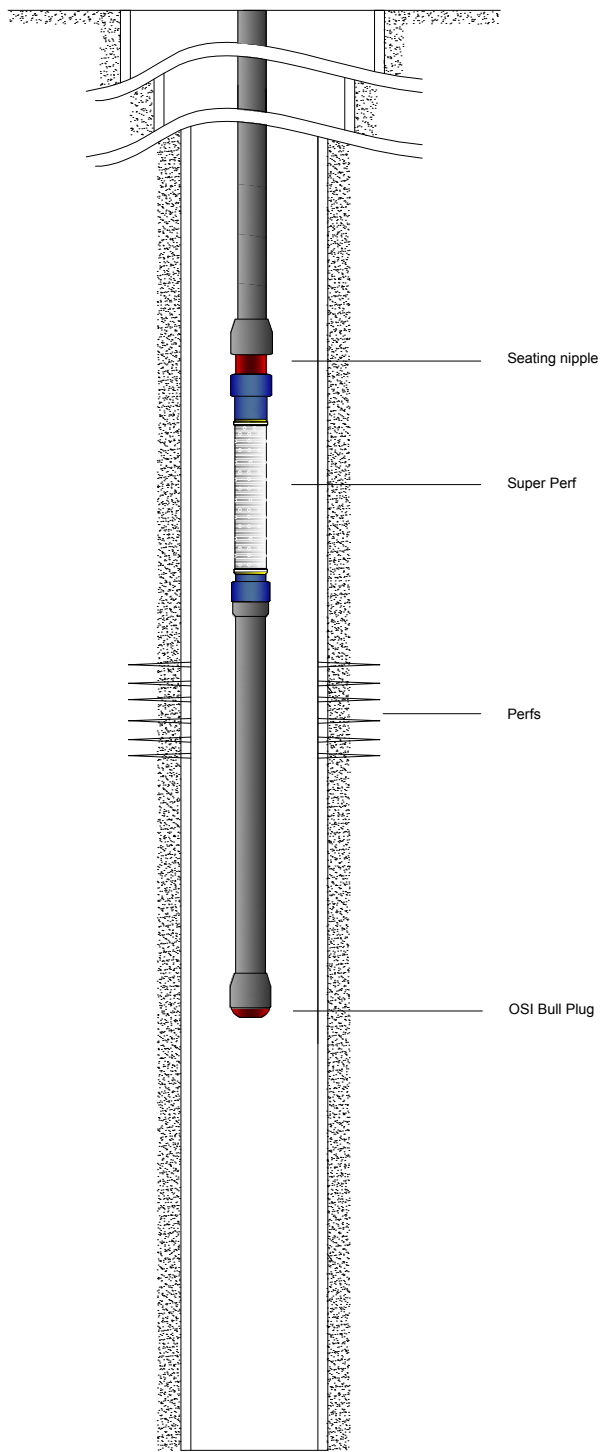

Company:
 Field:
 Well:

Config. 5.2 / Super Perf - Mud joint - Bull Plug

ODESSA
SEPARATOR, INC.

Phone: +1 (432) 580-7111
 Fax: +1 (432) 333-2015
 1612 Viceroy • Odessa, TX 79763, US
 ggonzalez@odessaseparator.com

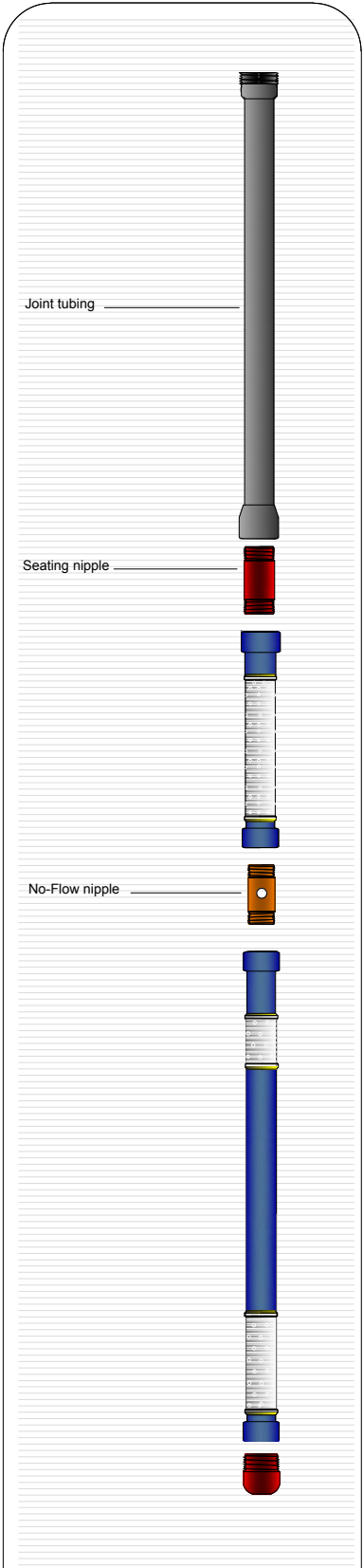
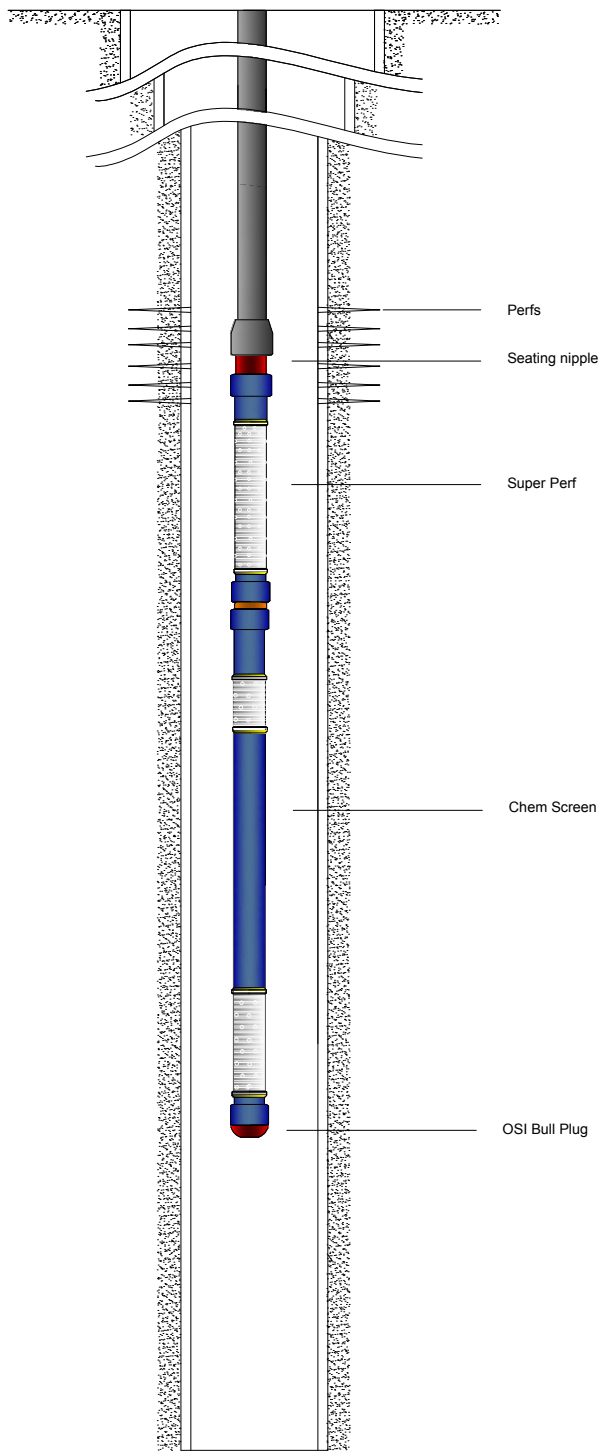

Company:
 Field:
 Well:

Config. 5.3 / Super Perf - Chem Screen - Bull Plug



Phone: +1 (432) 580-7111
 Fax: +1 (432) 333-2015
 1612 Viceroy • Odessa, TX 79763, US
 ggonzalez@odessaseparator.com

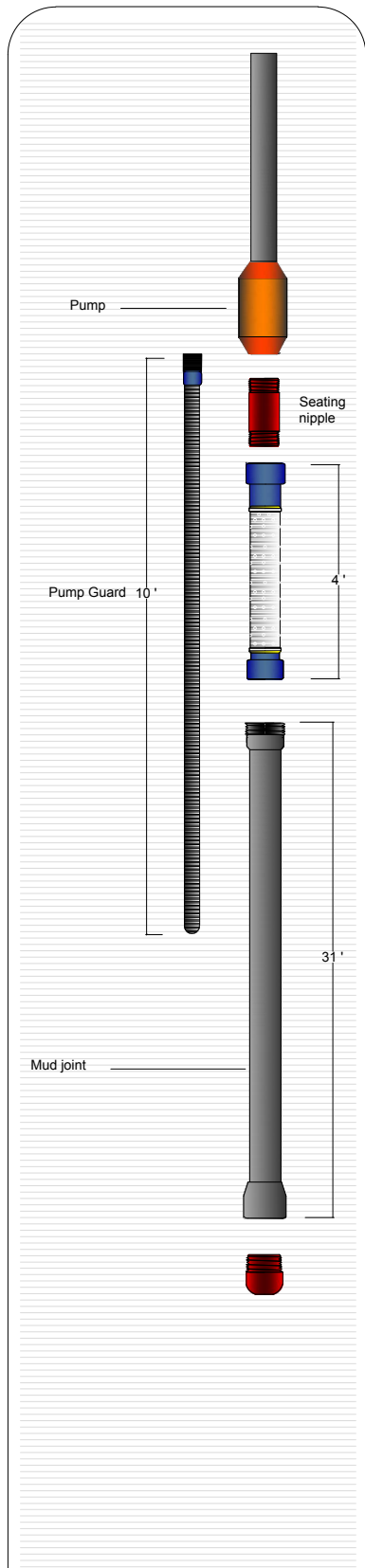
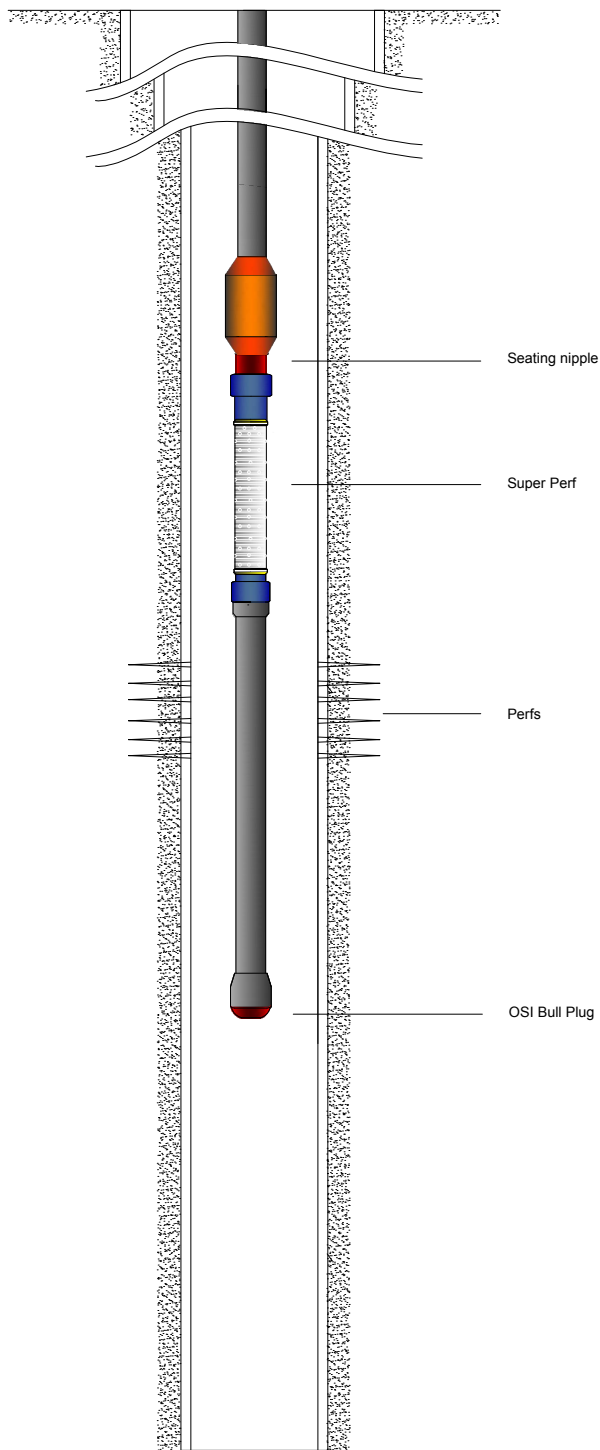

Company:
Field:
Well:

Config. 5.4 / Super Perf - Pump Guard - Mud joint - Bull Plug



Phone: +1 (432) 580-7111
Fax: +1 (432) 333-2015
1612 Viceroy • Odessa, TX 79763, US
ggonzalez@odessaseparator.com

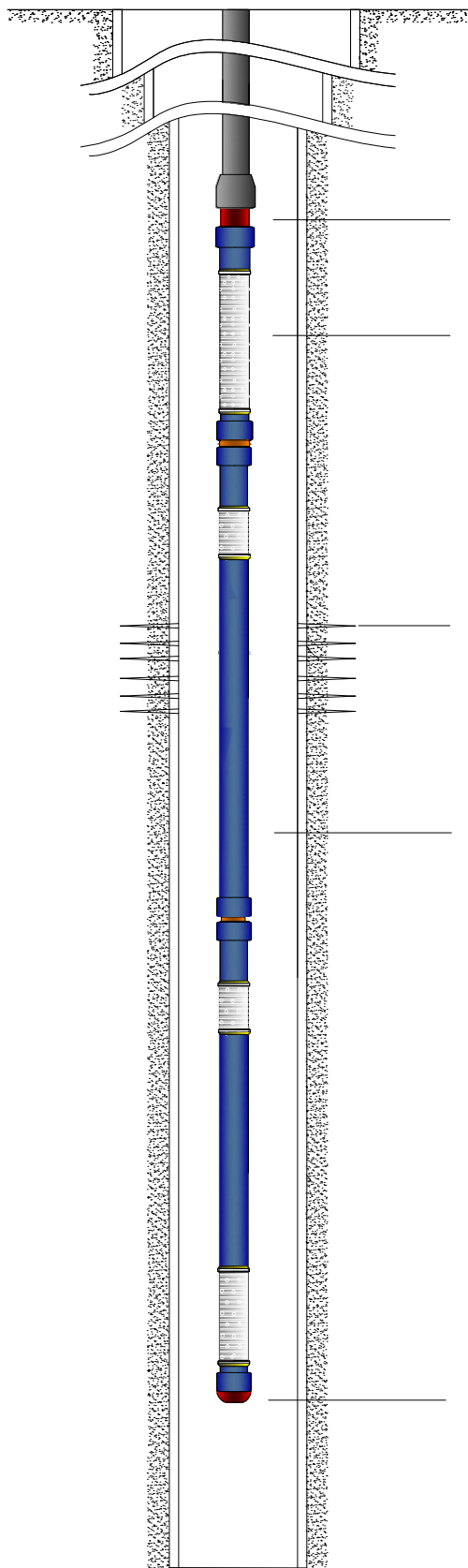

Seating nipple

Super Perf

Perfs

Extended Chem Screen

OSI Bull Plug

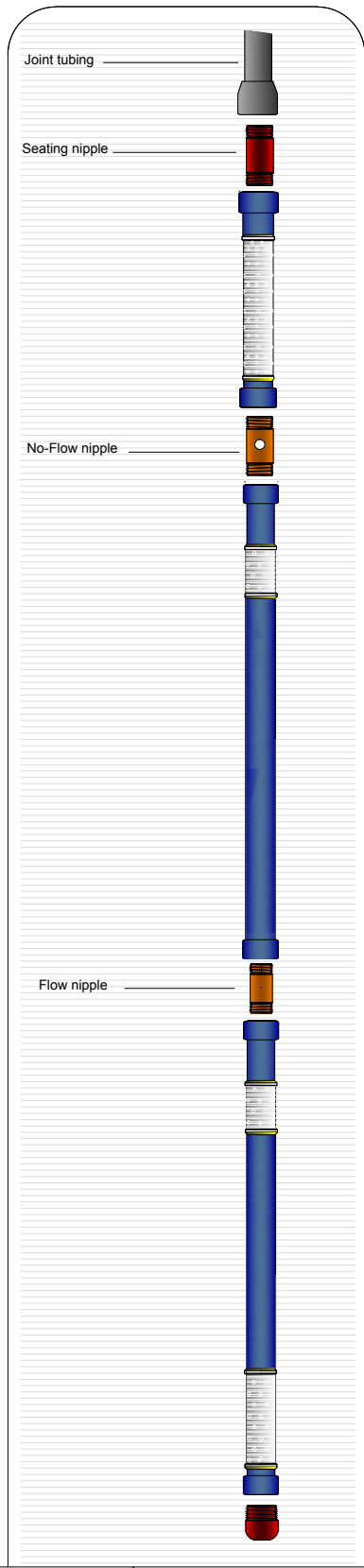

Joint tubing

Seating nipple

No-Flow nipple

Flow nipple

Company:
 Field:
 Well:

Config. 5.5 / Super Perf - Extended Chem Screen - Bull Plug

ODESSA
SEPARATOR, INC.

Phone: +1 (432) 580-7111
 Fax: +1 (432) 333-2015
 1612 Viceroy • Odessa, TX 79763, US
 ggonzalez@odessaseparator.com

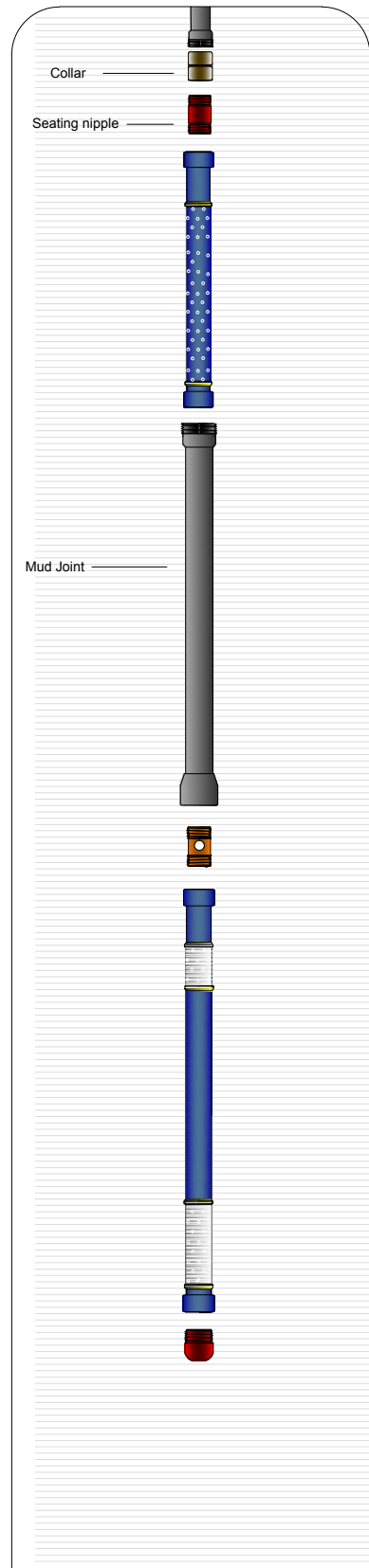
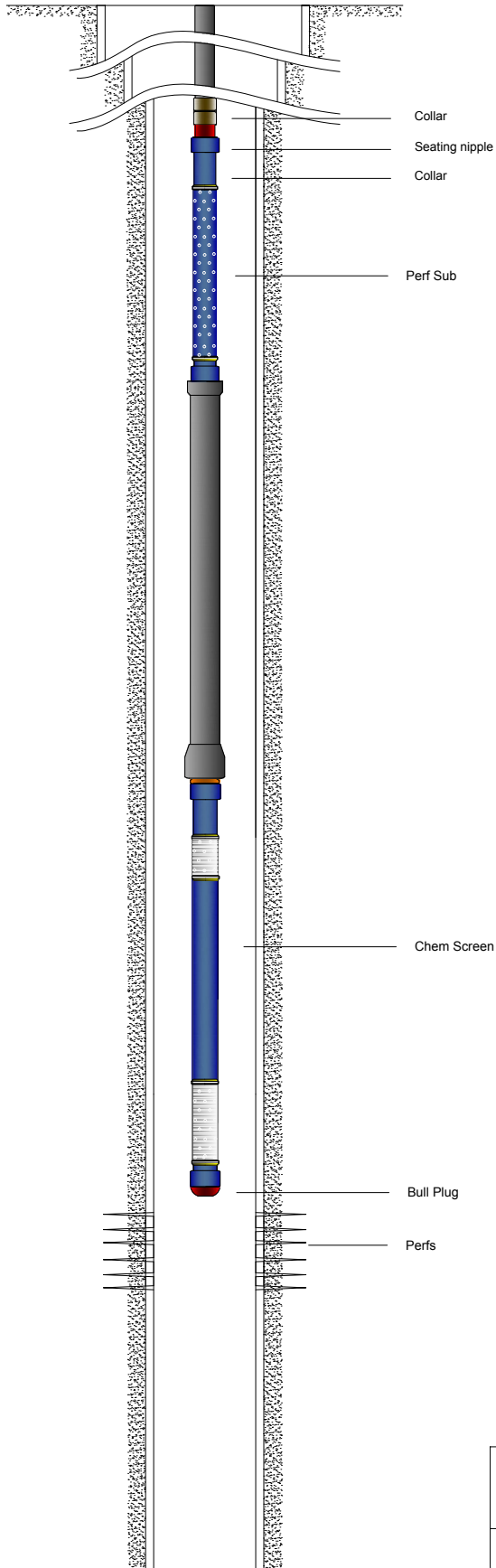

Company:
 Field:
 Well:

Config. 5.6 / Perf Sub- Mud joint- Chem Screen - Bull Plug

ODESSA
SEPARATOR, INC.

Phone: +1 (432) 580-7111
 Fax: +1 (432) 333-2015
 1612 Viceroy • Odessa, TX 79763, US
 ggonzalez@odsep.com

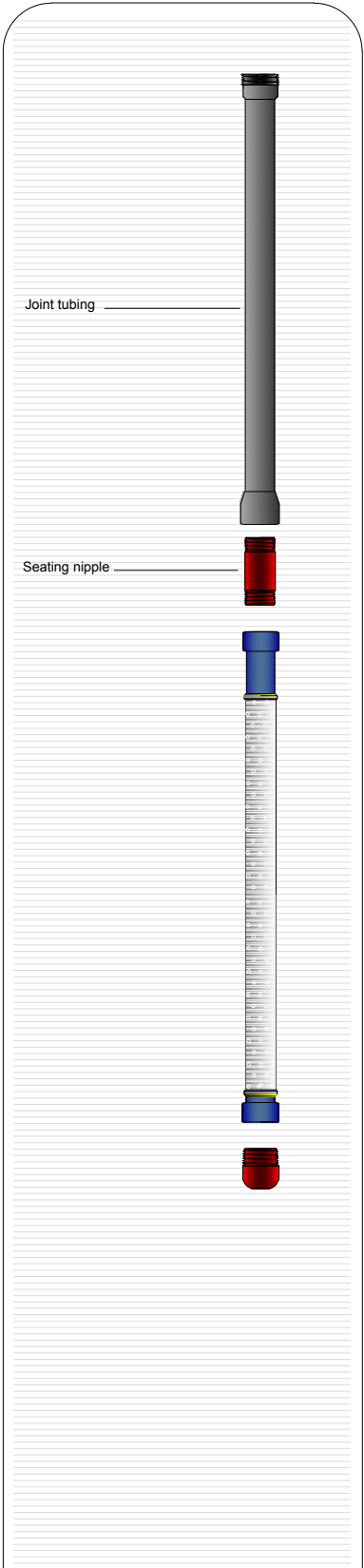
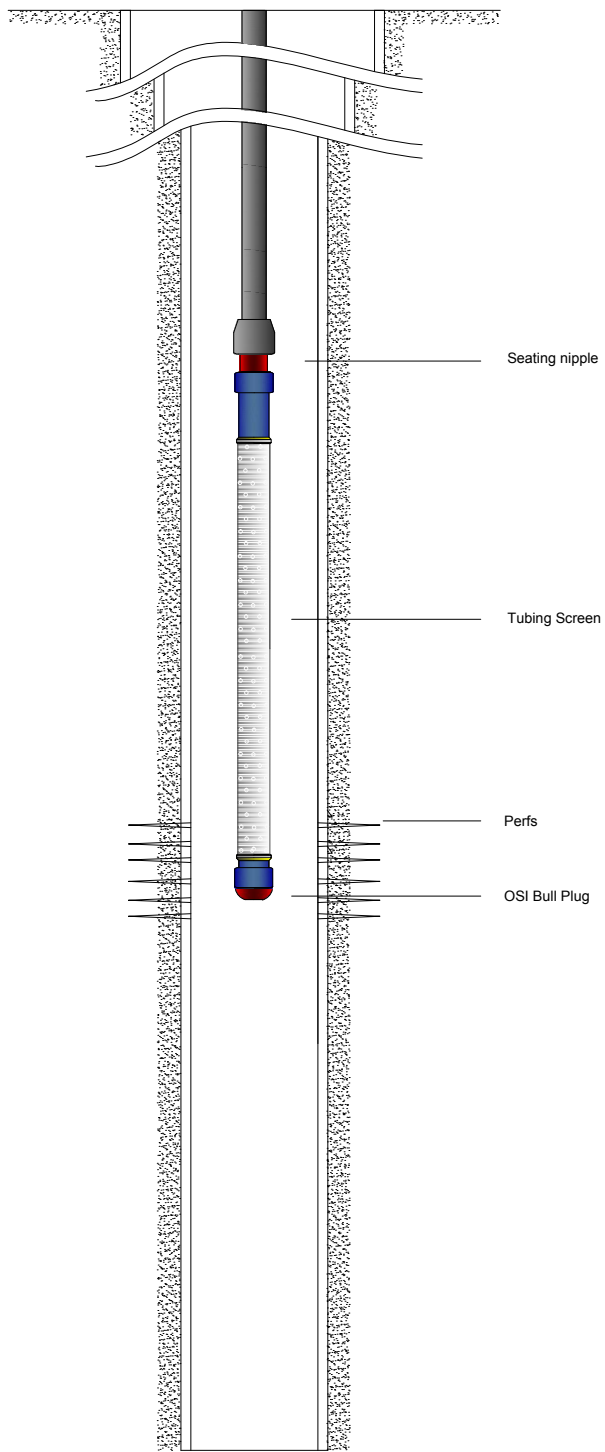

Company:
 Field:
 Well:

Config. 6.1 / Tubing Screen - Bull Plug



Phone: +1 (432) 580-7111
 Fax: +1 (432) 333-2015
 1612 Viceroy • Odessa, TX 79763, US
 ggonzalez@odessaseparator.com

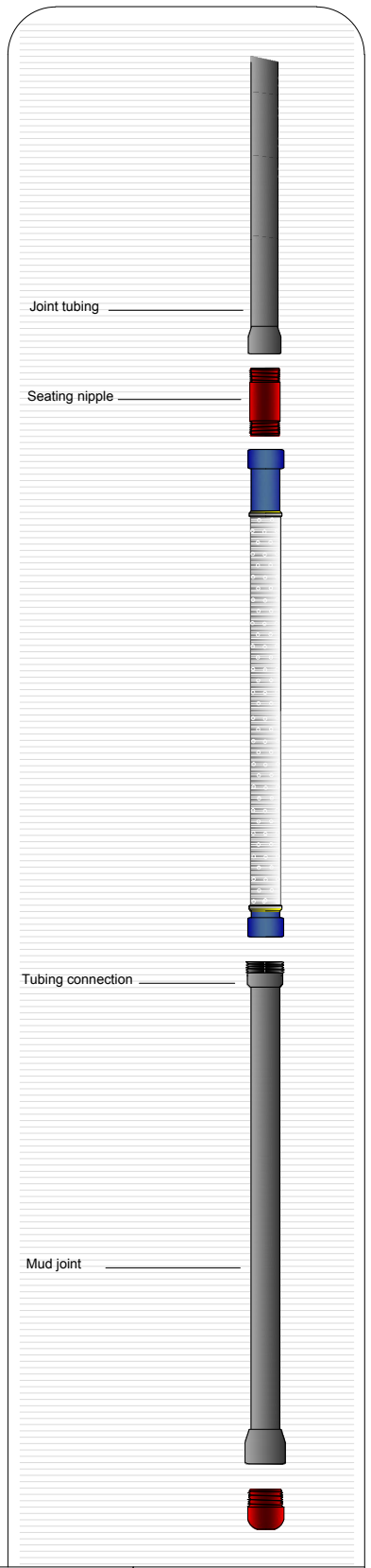
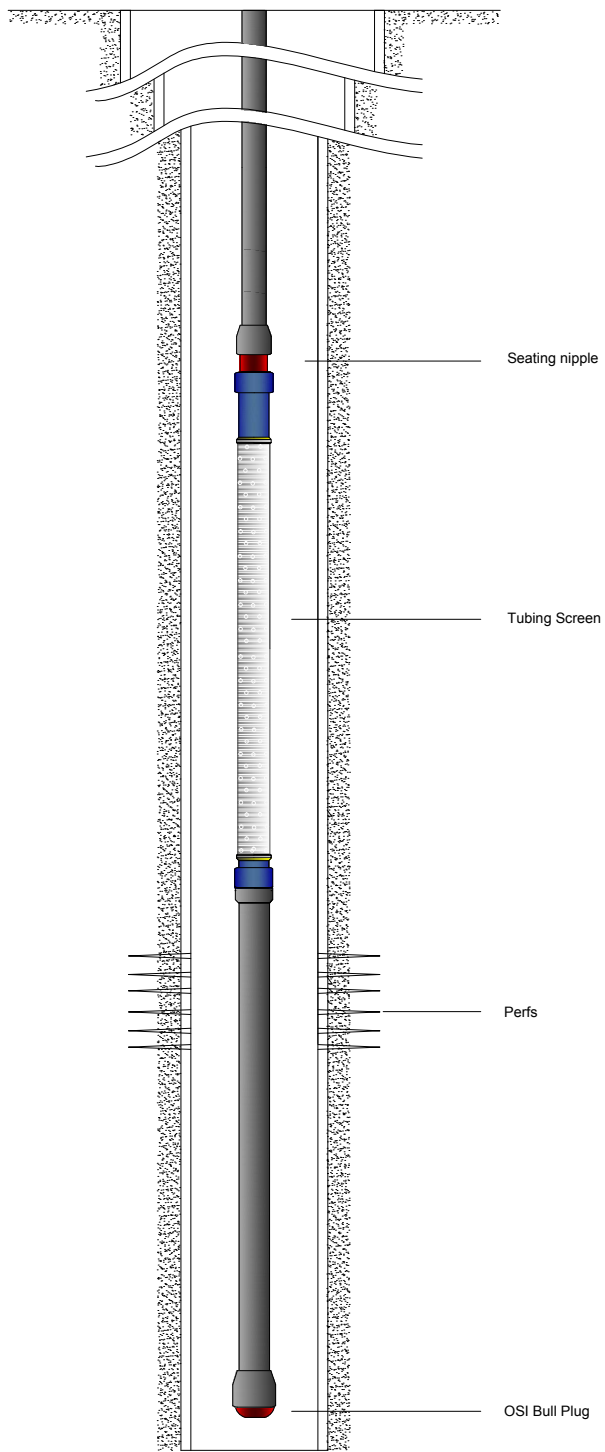

Company:
 Field:
 Well:

Config. 6.2 / Tubing Screen - Mud joint - Bull Plug



Phone: +1 (432) 580-7111
 Fax: +1 (432) 333-2015
 1612 Viceroy • Odessa, TX 79763, US
 ggonzalez@odessaseparator.com

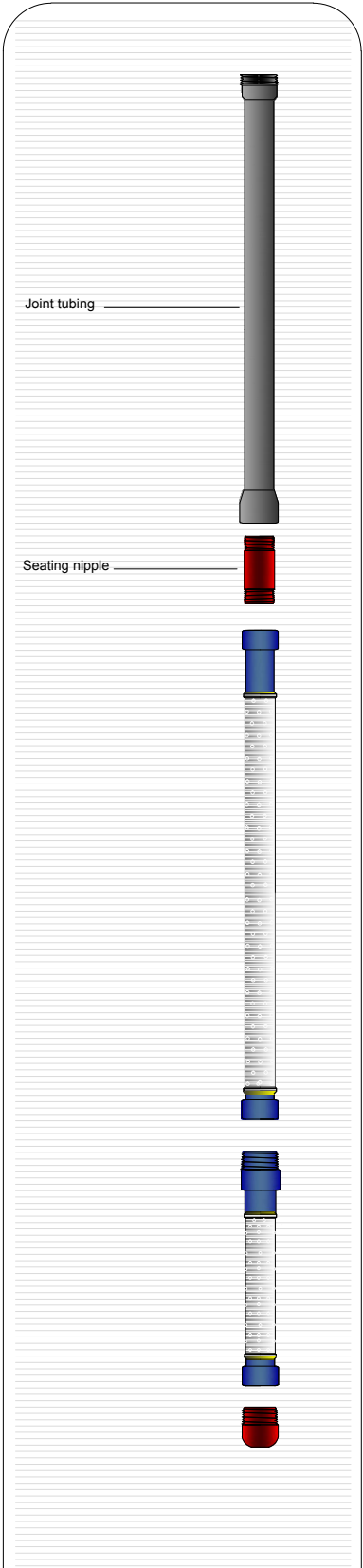
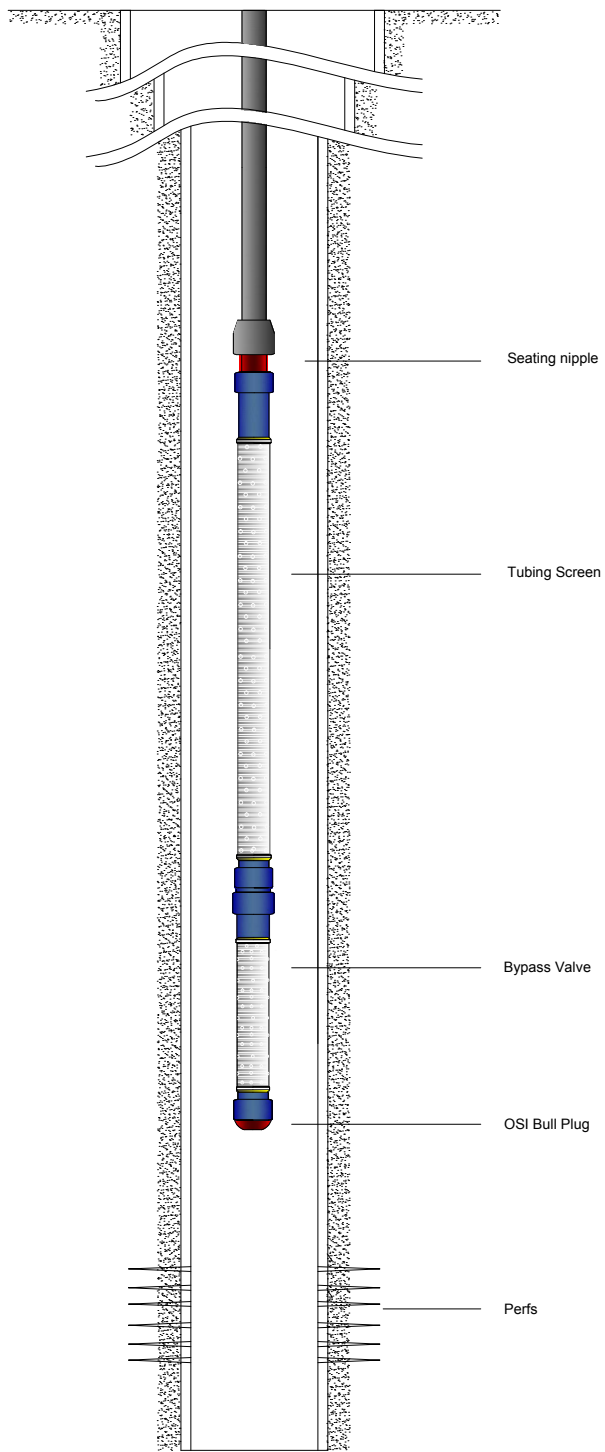

Company:
 Field:
 Well:

Config.6.3 / Tubing Screen - Bypass Valve - Bull Plug

ODESSA
SEPARATOR, INC.

Phone: +1 (432) 580-7111
 Fax: +1 (432) 333-2015
 1612 Viceroy • Odessa, TX 79763, US
ggonzalez@odessaseparator.com

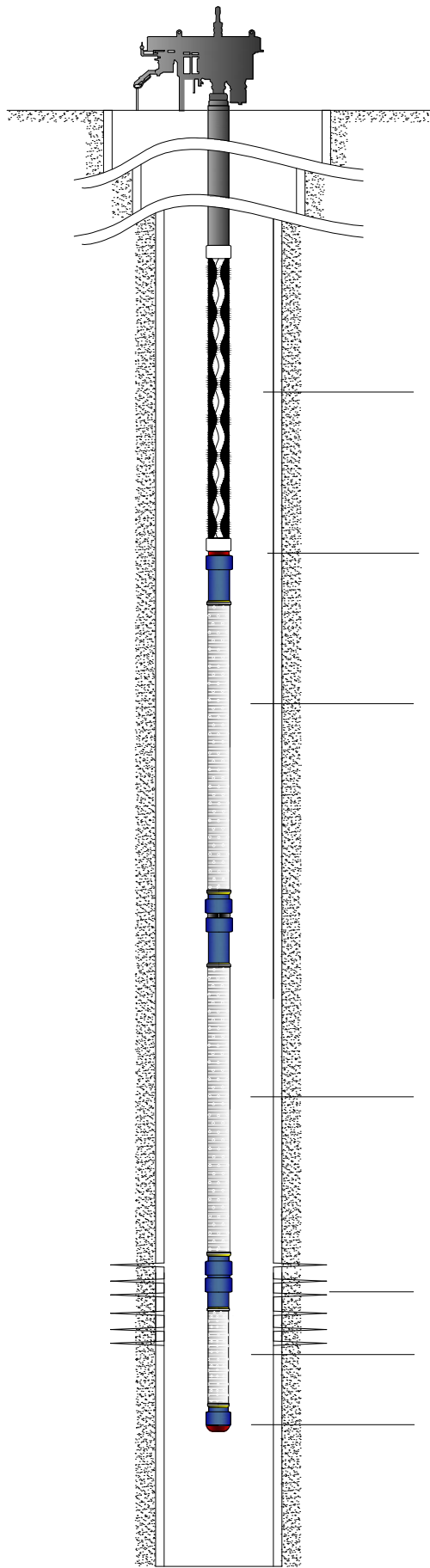

PC pump

Seating nipple

Tubing Screen

Tubing Screen

Perfs

Bypass valve

Bull Plug

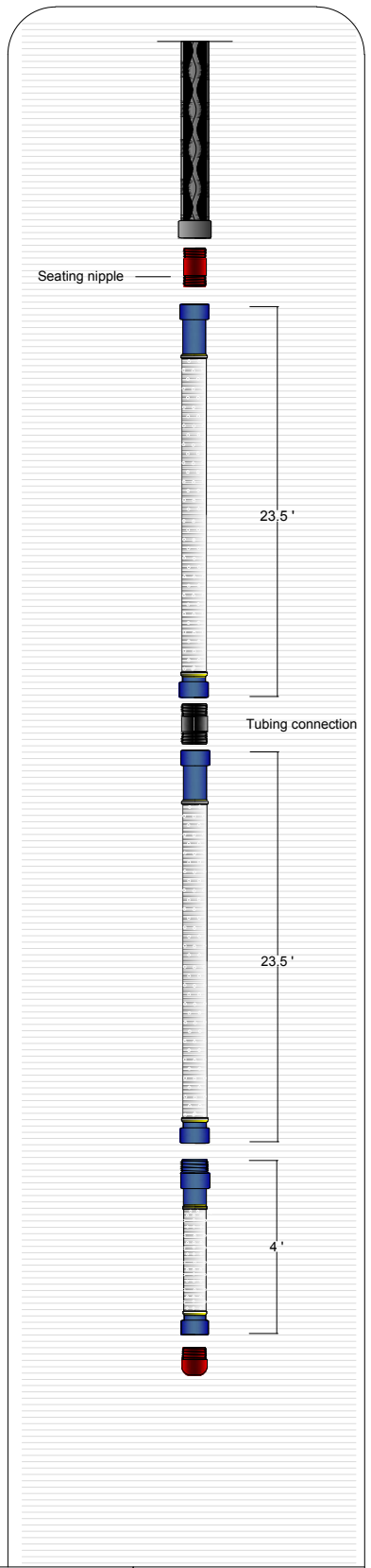

Seating nipple

23.5'

Tubing connection

23.5'

4'

Company :
 Field:
 Well:
 Config. 6.4 / Tubing Screen (2)- Bypass Valve - Bull Plug
 with Pc. Pump .

ODESSA
SEPARATOR, INC.

Phone: +1 (432) 580-7111
 Fax: +1 (432) 333-2015
 1612 Viceroy • Odessa, TX 79763, US
 ggonzalez@odessaseparator.com

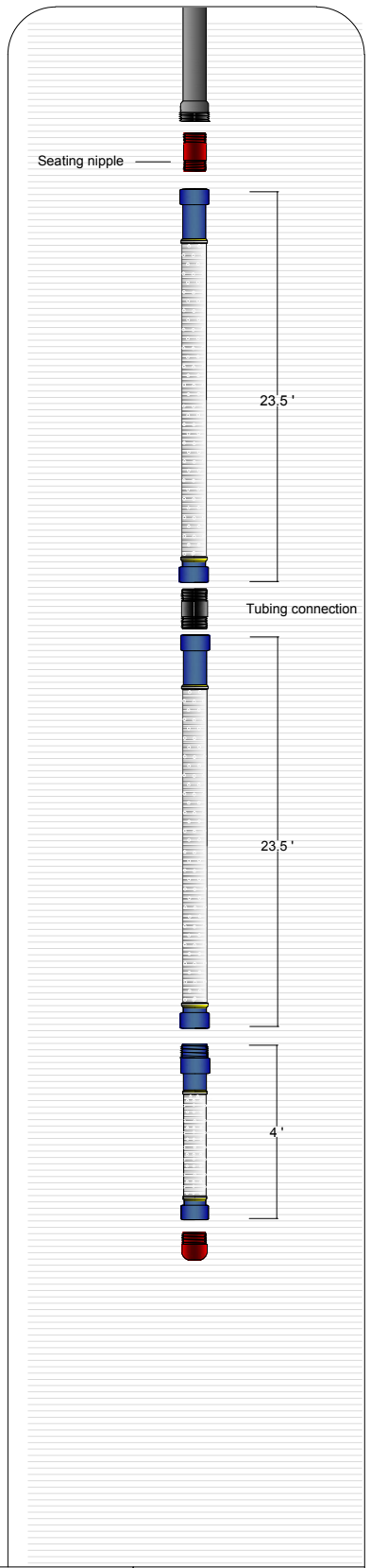
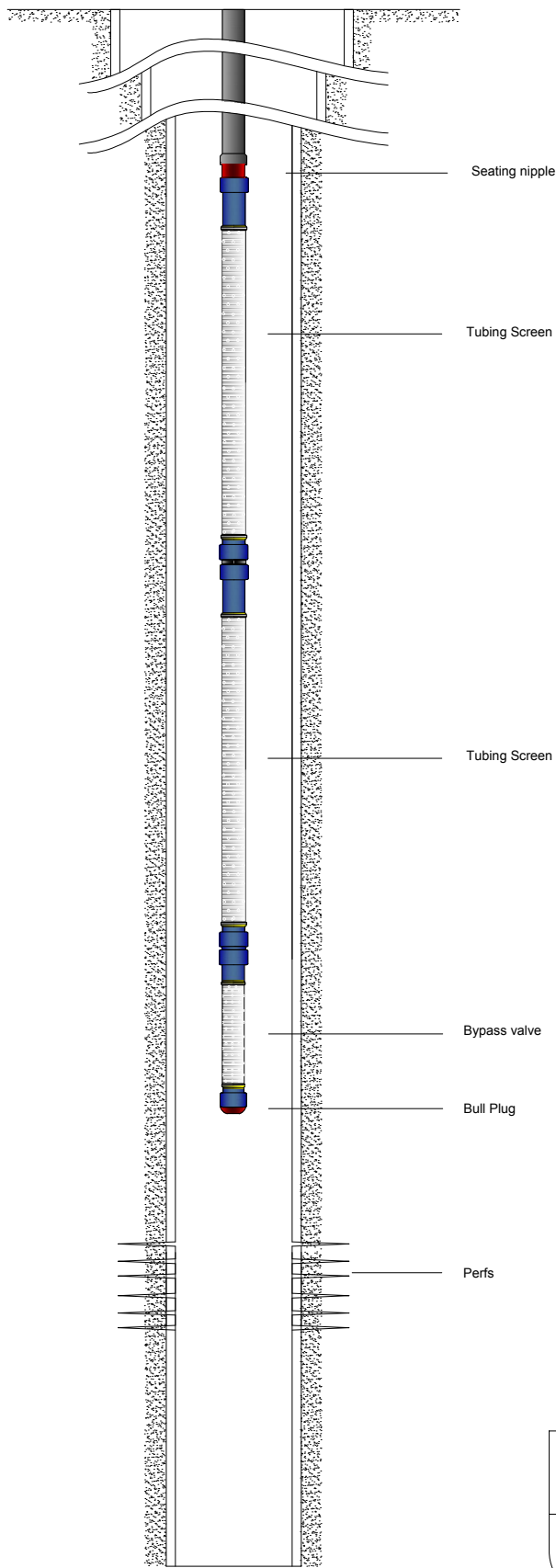

Company :
 Field:
 Well:

Config. 6.5 / Tubing Screen (2)- Bypass Valve - Bull Plug.

ODESSA
SEPARATOR, INC.

Phone: +1 (432) 580-7111
 Fax: +1 (432) 333-2015
 1612 Viceroy • Odessa, TX 79763, US
 ggonzalez@odessaseparator.com

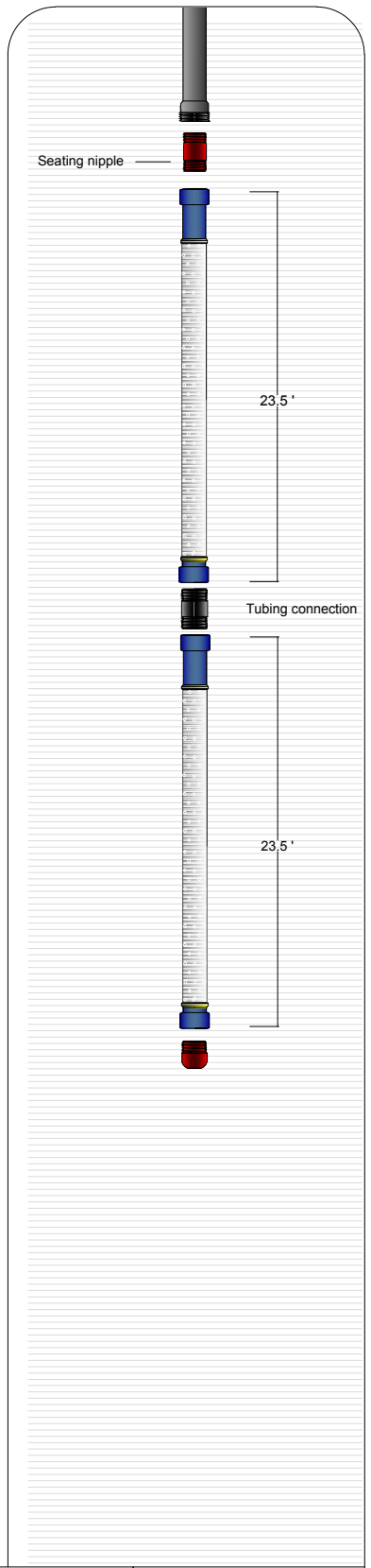
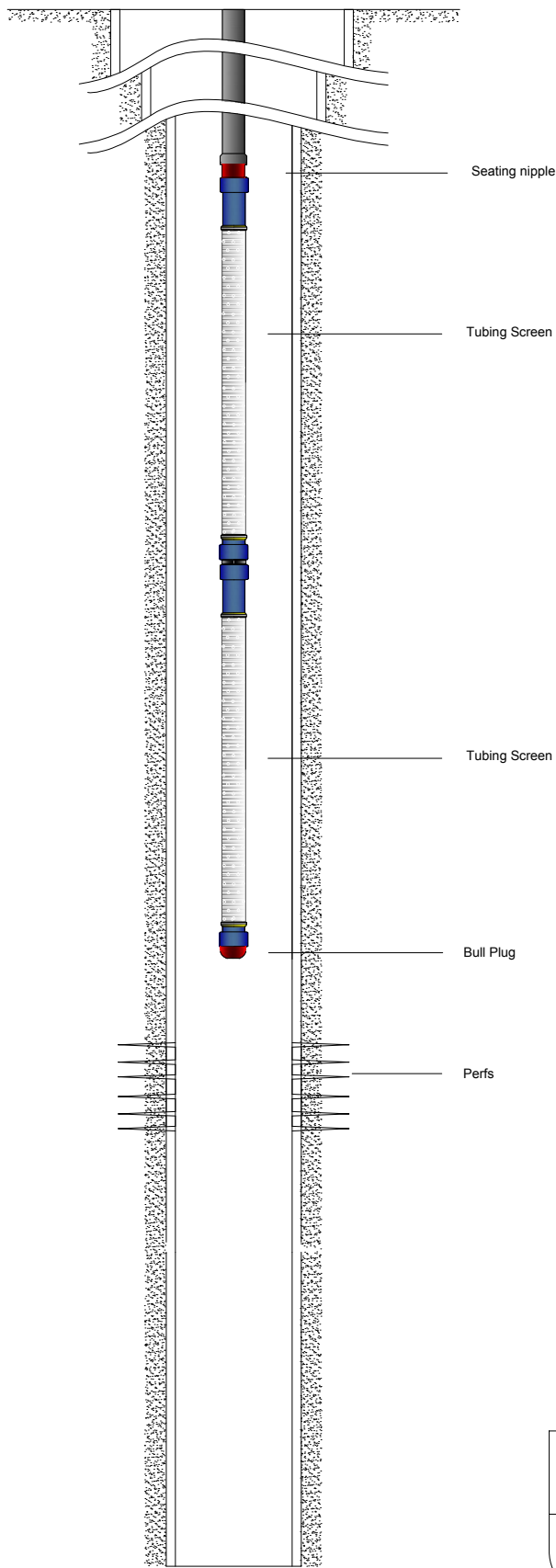

Company :
 Field:
 Well:

Config. 6.6 / Tubing Screen (2) - Bull Plug.

ODESSA
SEPARATOR, INC.

Phone: +1 (432) 580-7111
 Fax: +1 (432) 333-2015
 1612 Viceroy • Odessa, TX 79763, US
 ggonzalez@odessaseparator.com

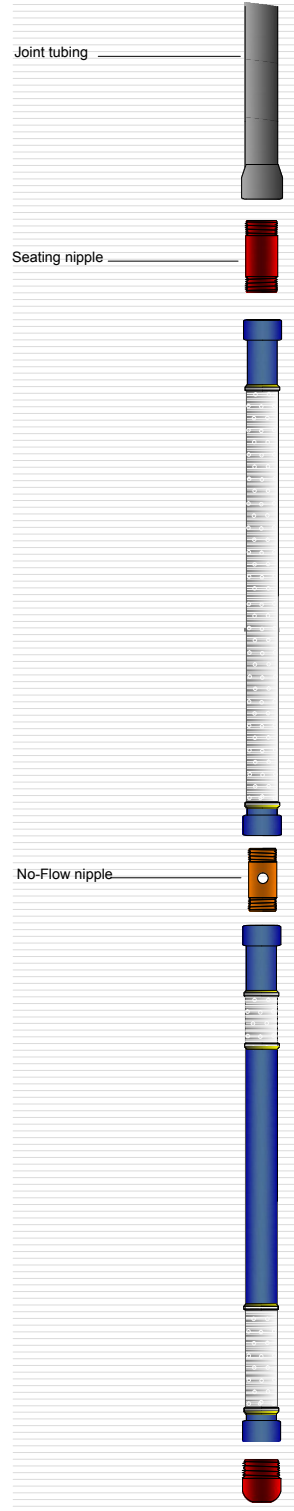
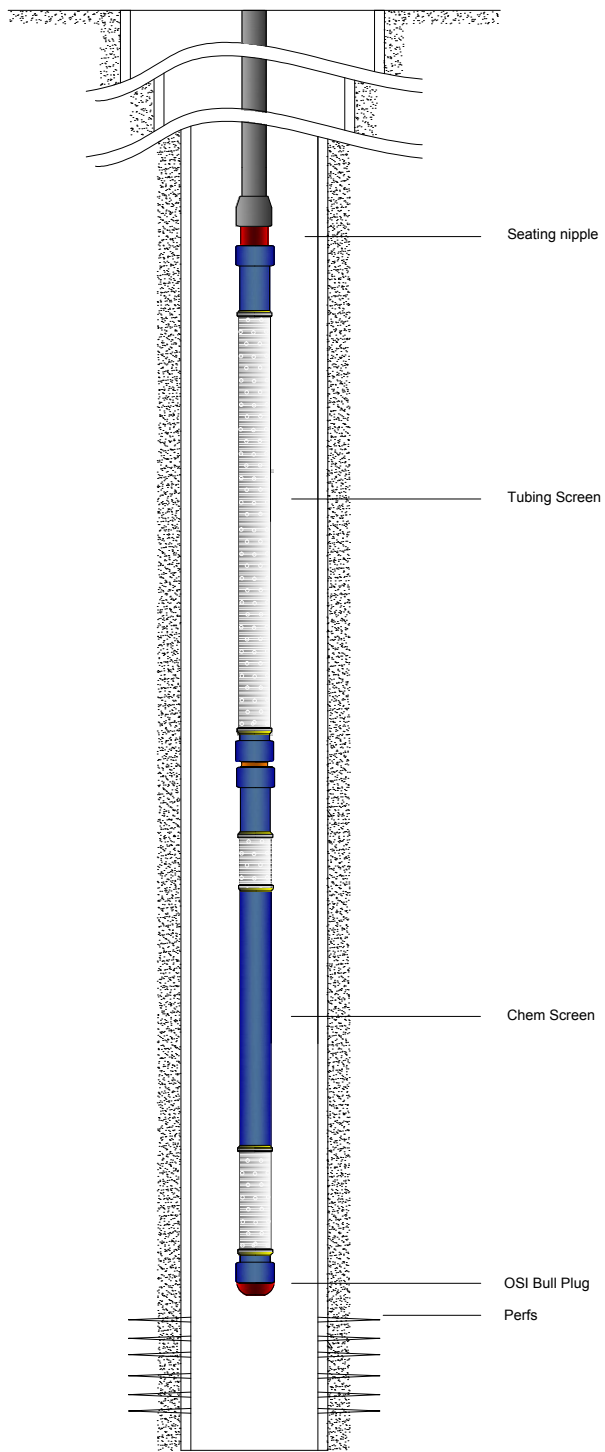

Company:
 Field:
 Well:

Config. 7.1 / Tubing Screen - Chem Screen - Bull Plug

ODESSA
SEPARATOR, INC.

Phone: +1 (432) 580-7111
 Fax: +1 (432) 333-2015
 1612 Viceroy • Odessa, TX 79763, US
 ggonzalez@odessaseparator.com

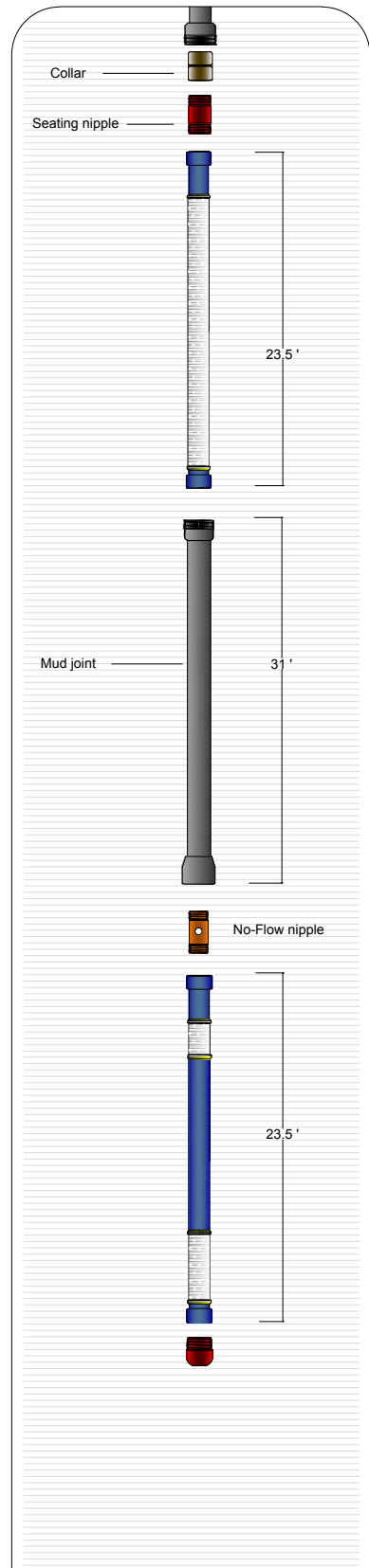
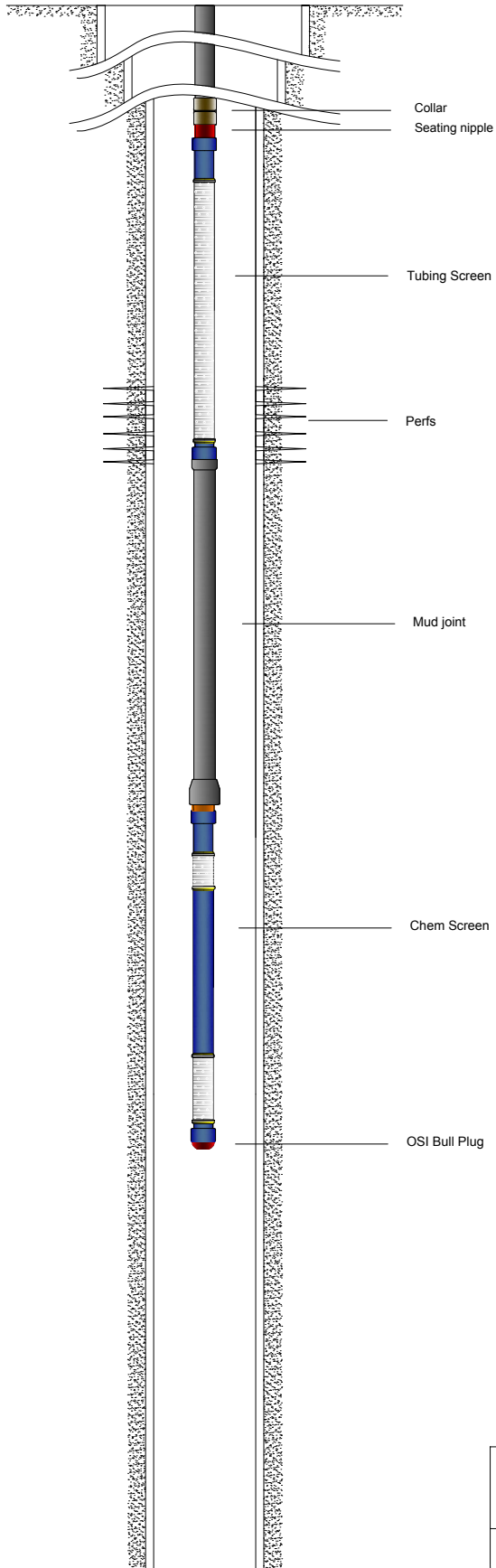

Company:
 Field:
 Well:

Config. 7.2 / Tubing Screen - Mud joint - Chem Screen - Bull Plug

ODESSA
SEPARATOR, INC.

Phone: +1 (432) 580-7111
 Fax: +1 (432) 333-2015
 1612 Viceroy • Odessa, TX 79763, US
 ggonzalez@odessaseparator.com

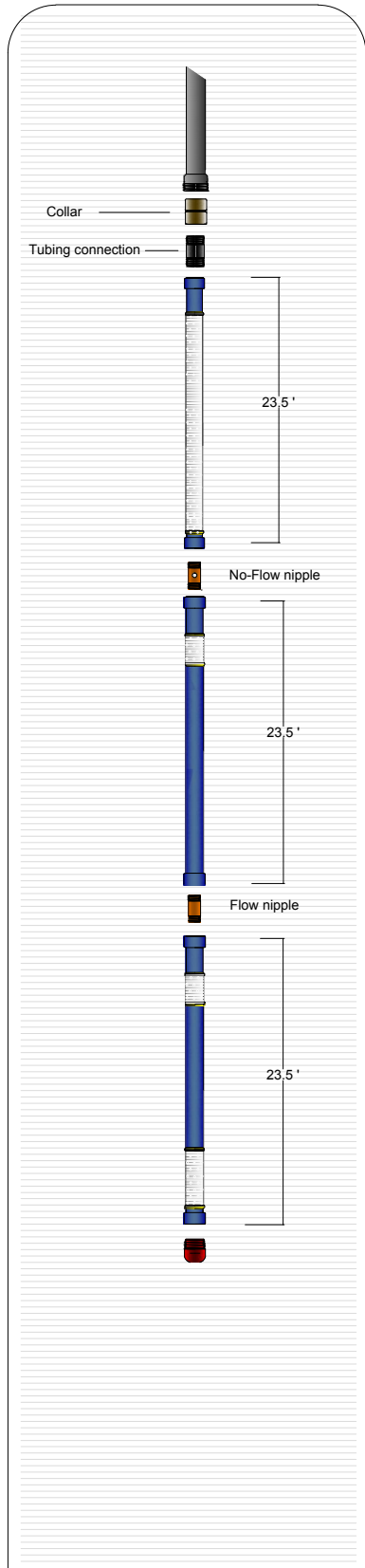
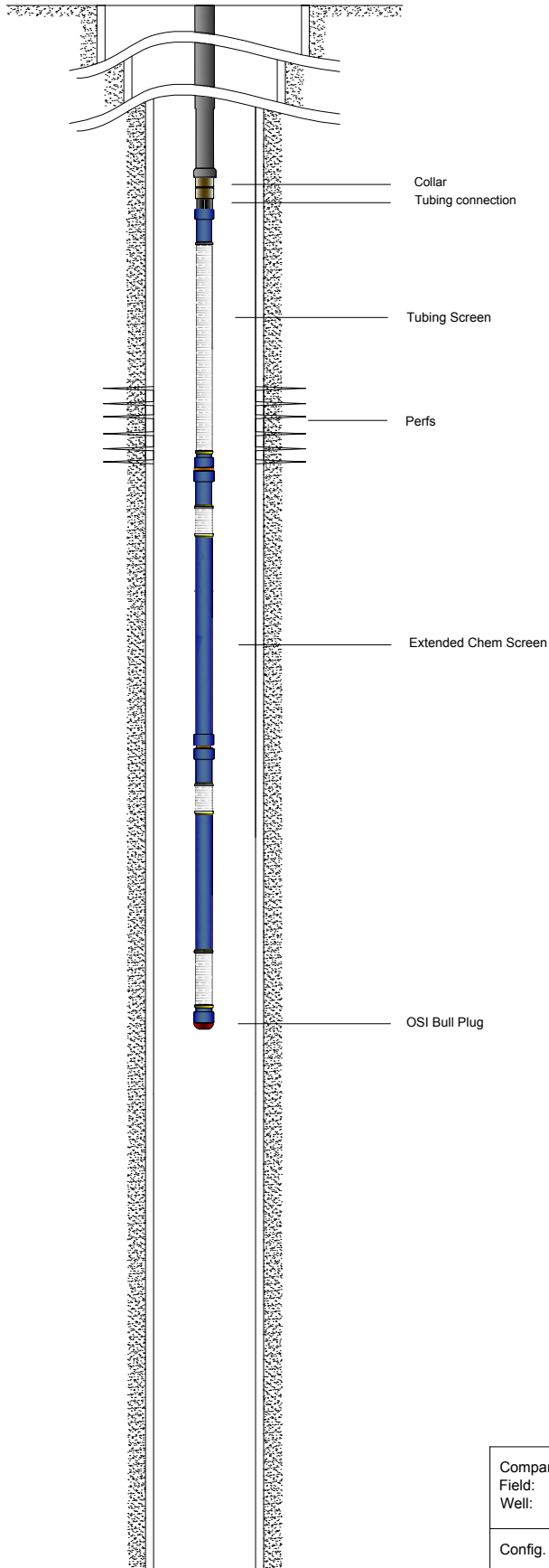

Company:
 Field:
 Well:

Config. 7.3 / Tubing Screen - Ext. Chem Screen - Bull Plug

ODESSA
SEPARATOR, INC.

Phone: +1 (432) 580-7111
 Fax: +1 (432) 333-2015
 1612 Viceroy • Odessa, TX 79763, US
 ggonzalez@odessaseparator.com

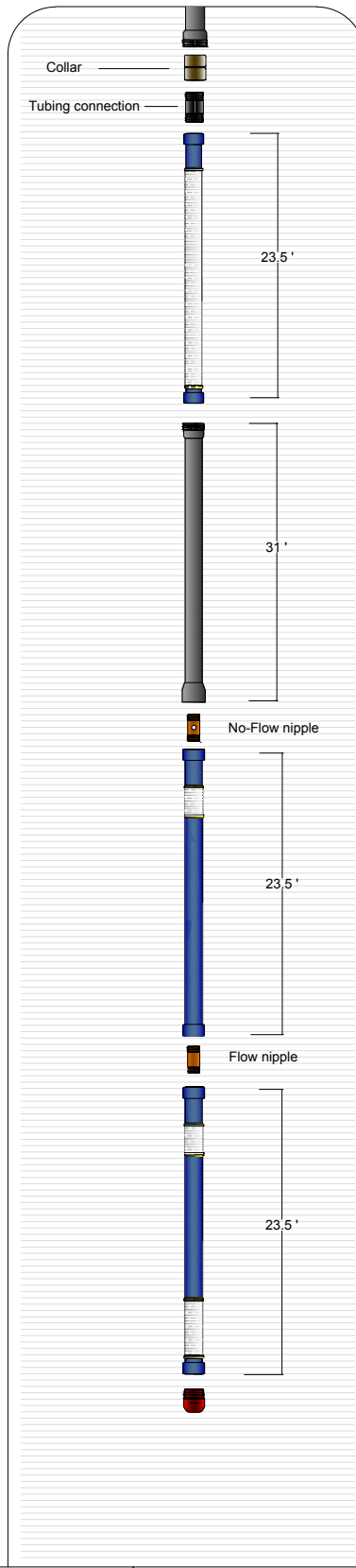
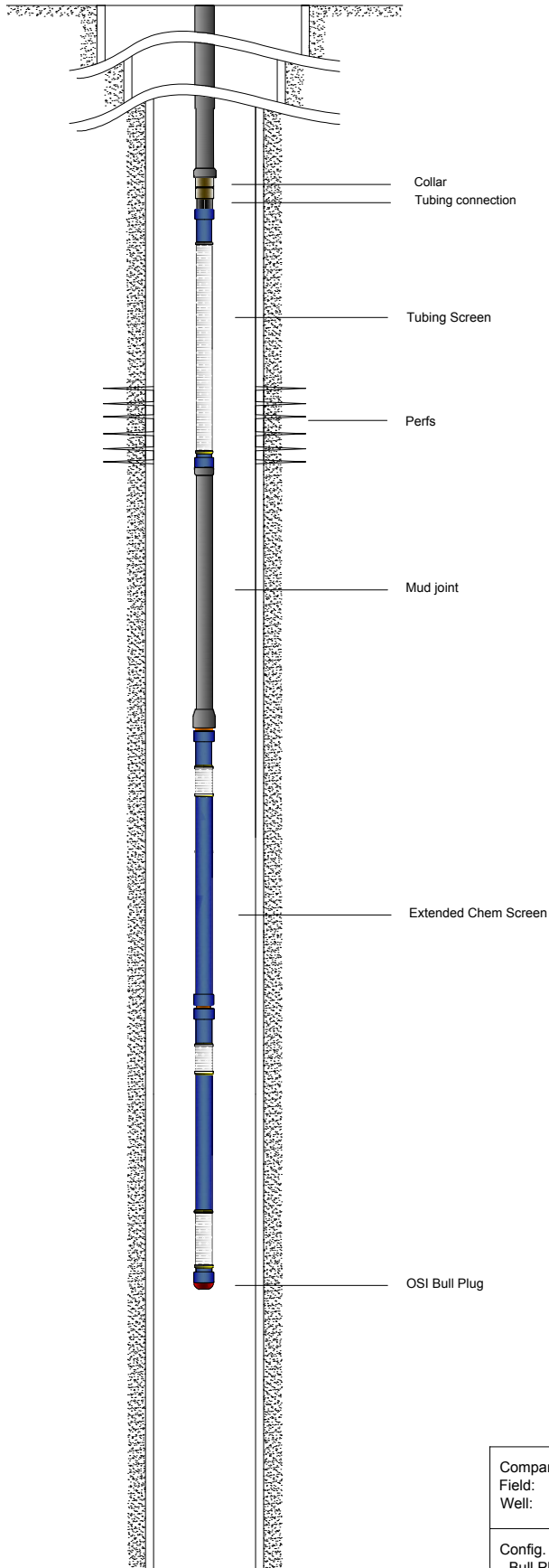

Company:
 Field:
 Well:

Config. 7.4 / Tubing Screen - Mud joint - Ext. Chem Screen
 - Bull Plug

ODESSA
SEPARATOR, INC.

Phone: +1 (432) 580-7111
 Fax: +1 (432) 333-2015
 1612 Viceroy • Odessa, TX 79763, US
 ggonzalez@odessaseparator.com

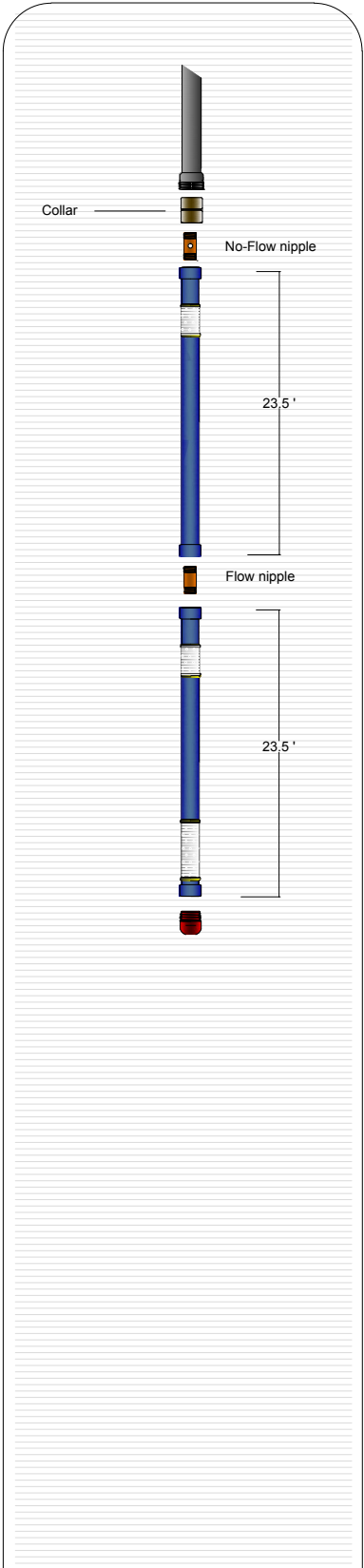
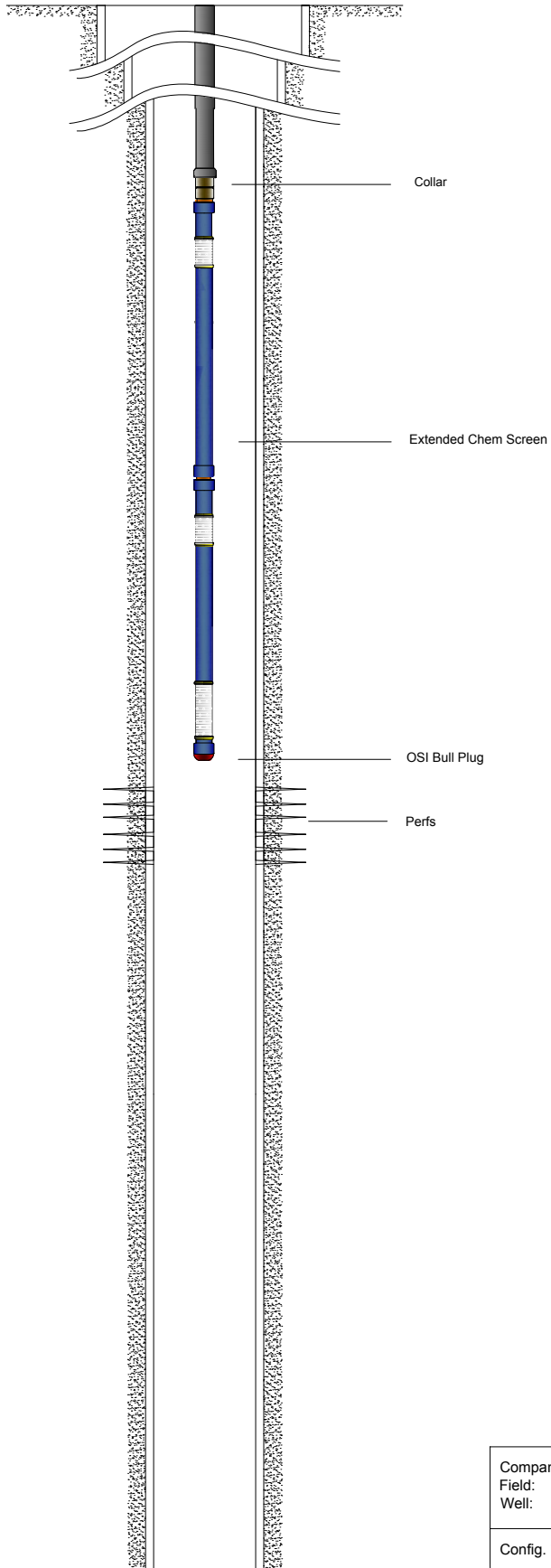

Company:
 Field:
 Well:

Config. 7.5 / Ext. Chem Screen - Bull Plug



Phone: +1 (432) 580-7111
 Fax: +1 (432) 333-2015
 1612 Viceroy • Odessa, TX 79763, US
 ggonzalez@odsep.com

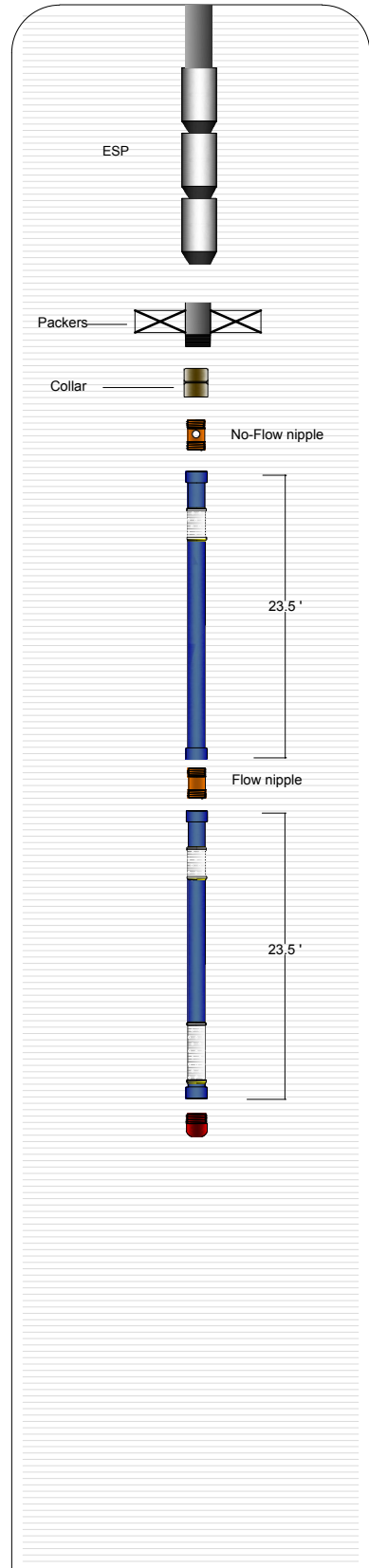
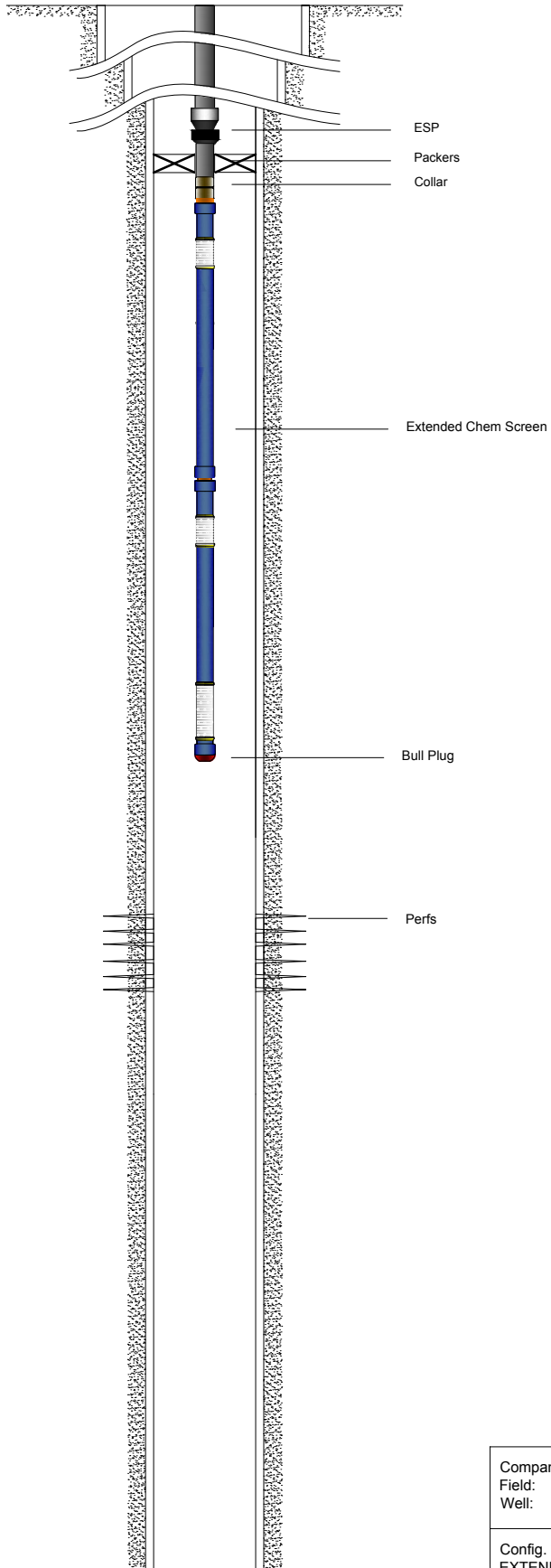

Company:
Field:
Well:

Config. 7.6 / ESP - PACKER - NO-FLOW NIPPLE - 48 FT
EXTENDED CHEMICAL SCREEN - BULL PLUG



Phone: +1 (432) 580-7111
Fax: +1 (432) 333-2015
1612 Viceroy • Odessa, TX 79763, US
ggonzalez@odsep.com

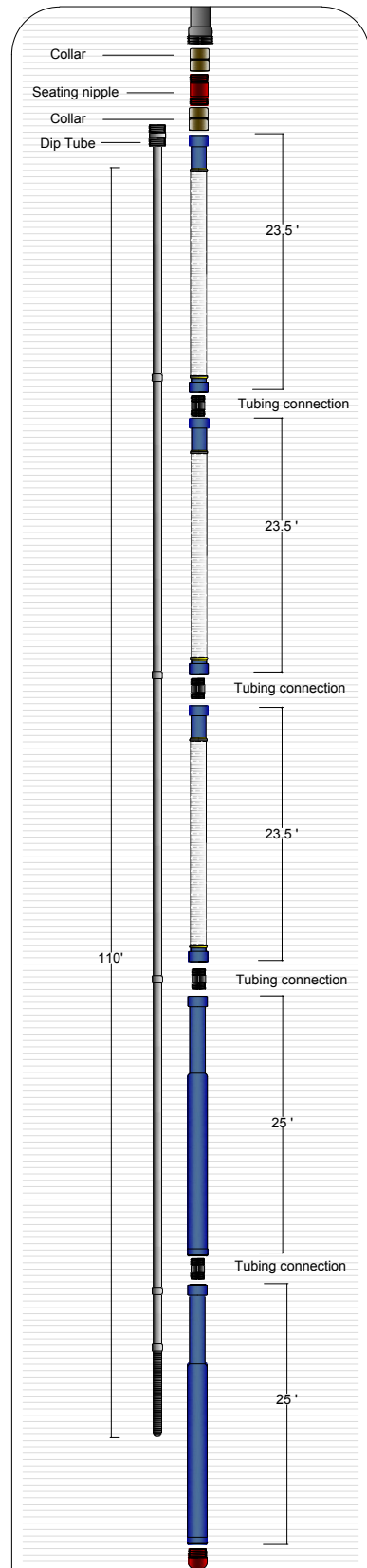
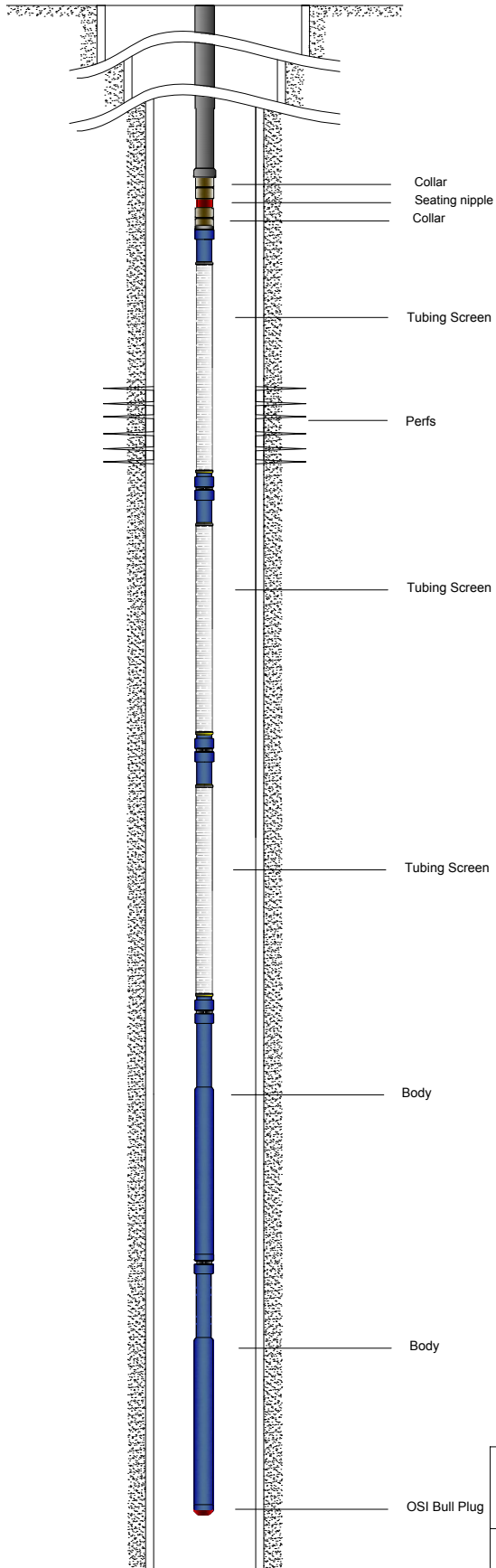

Company:
Field:
Well:

Config. 8.1 / Dual Body Super Gas & Sand Shield with 110'
- Bull Plug



Phone: +1 (432) 580-7111
Fax: +1 (432) 333-2015
1612 Viceroy • Odessa, TX 79763, US
ggonzalez@odessaseparator.com

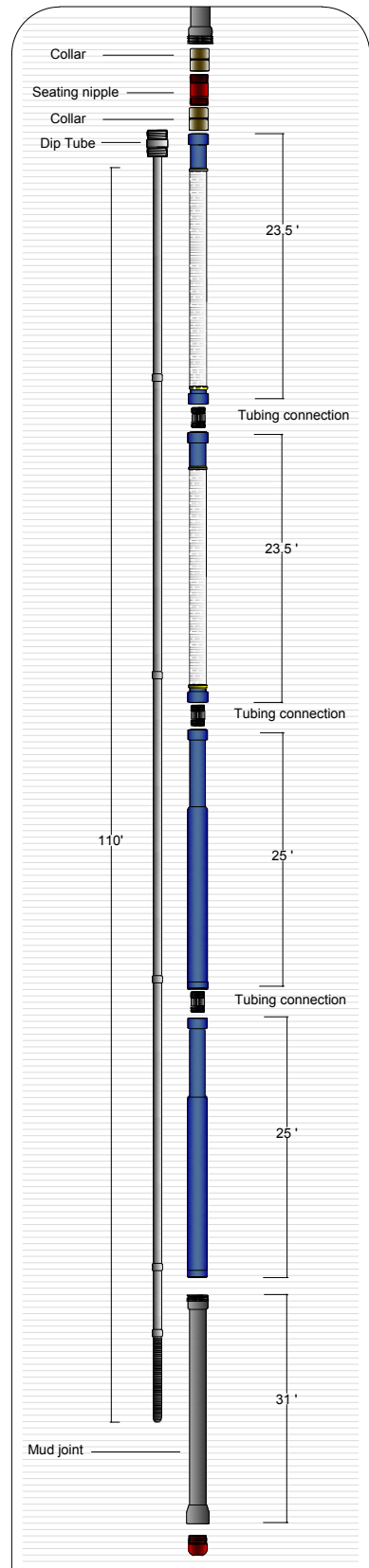
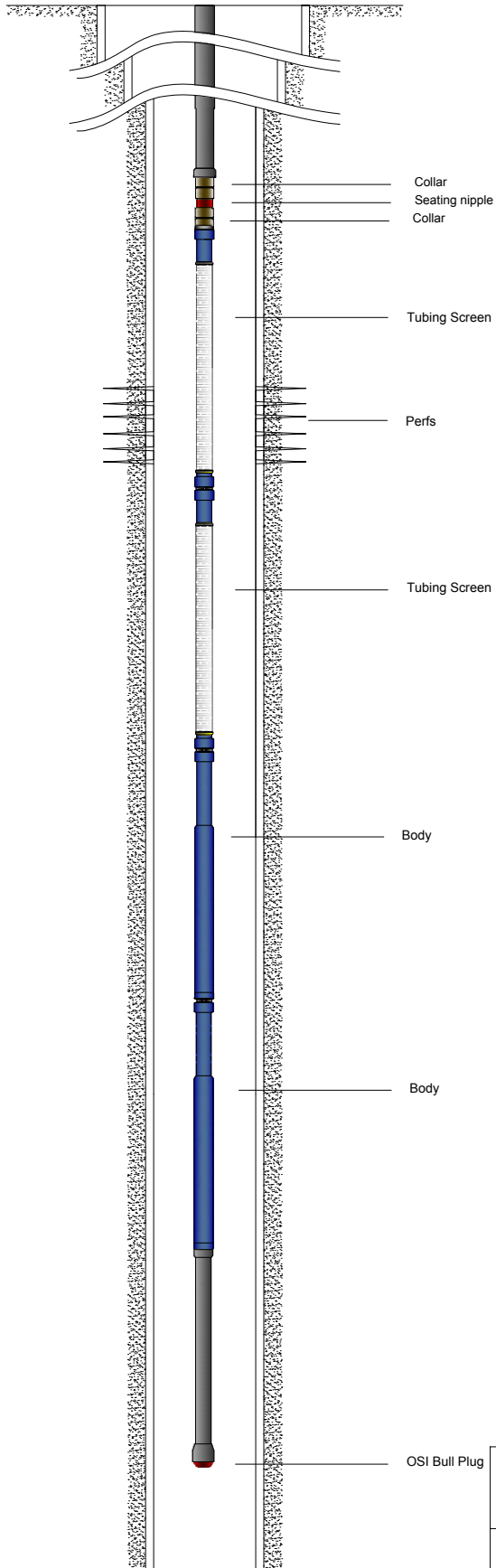

Company:
Field:
Well:

Config. 8.2 / Dual Body Super Gas & Sand Shield with 110'
- Mud joint - Bull Plug



Phone: +1 (432) 580-7111
Fax: +1 (432) 333-2015
1612 Viceroy • Odessa, TX 79763, US
ggonzalez@odessaseparator.com

Assembly Above Mud joint

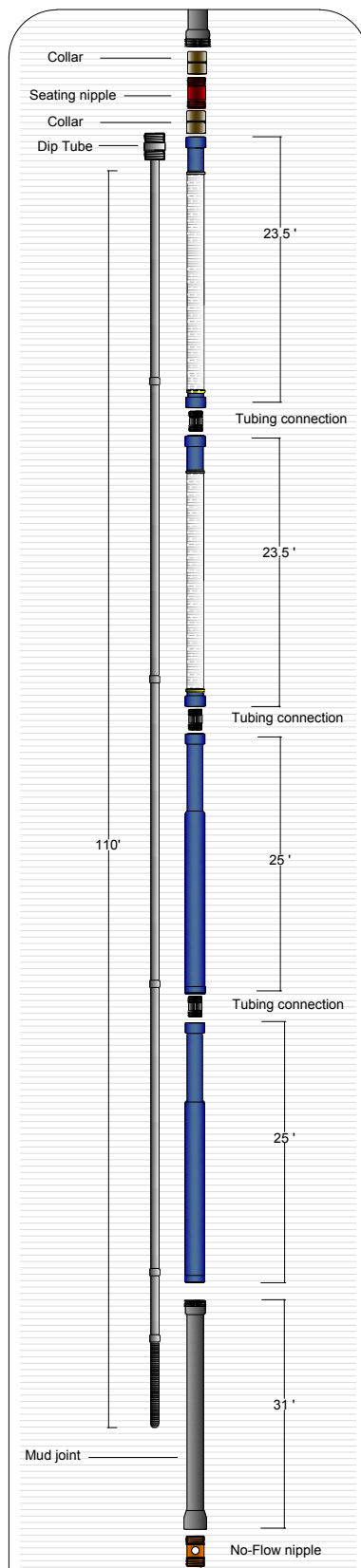
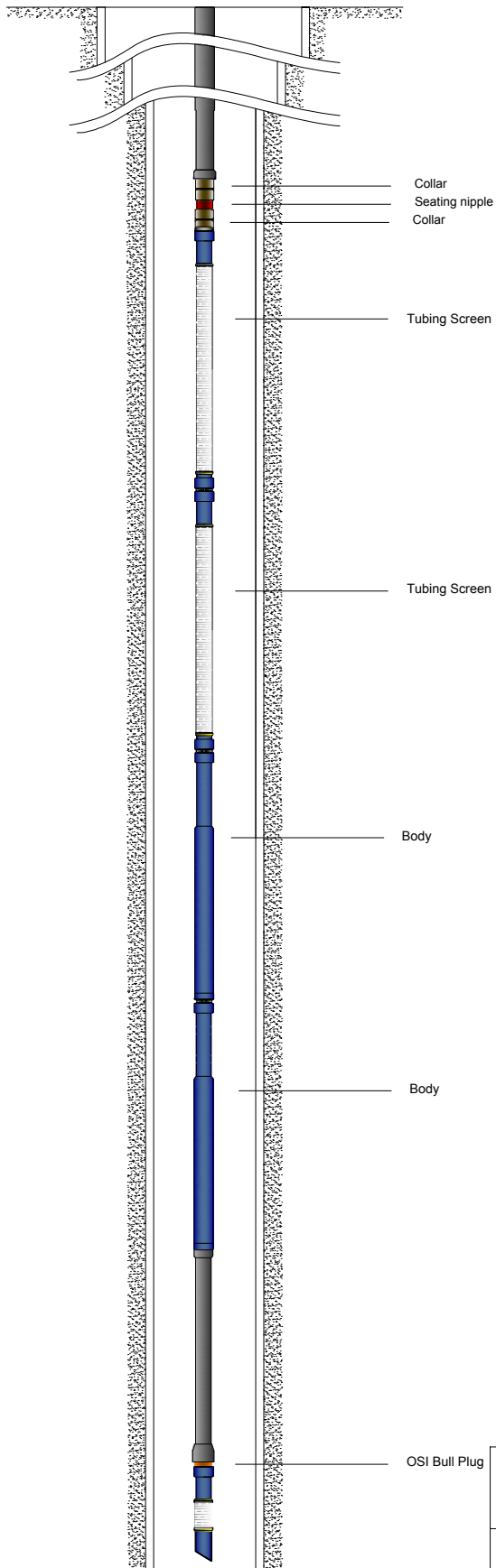

Company:
Field:
Well:

Config. 8.3.1 / Dual Body Super Gas & Sand Shield with
110' - Mud joint - Chem Screen- Bull Plug



Phone: +1 (432) 580-7111
Fax: +1 (432) 333-2015
1612 Viceroy • Odessa, TX 79763, US
ggonzalez@odessaseparator.com

Assembly Below Mud joint

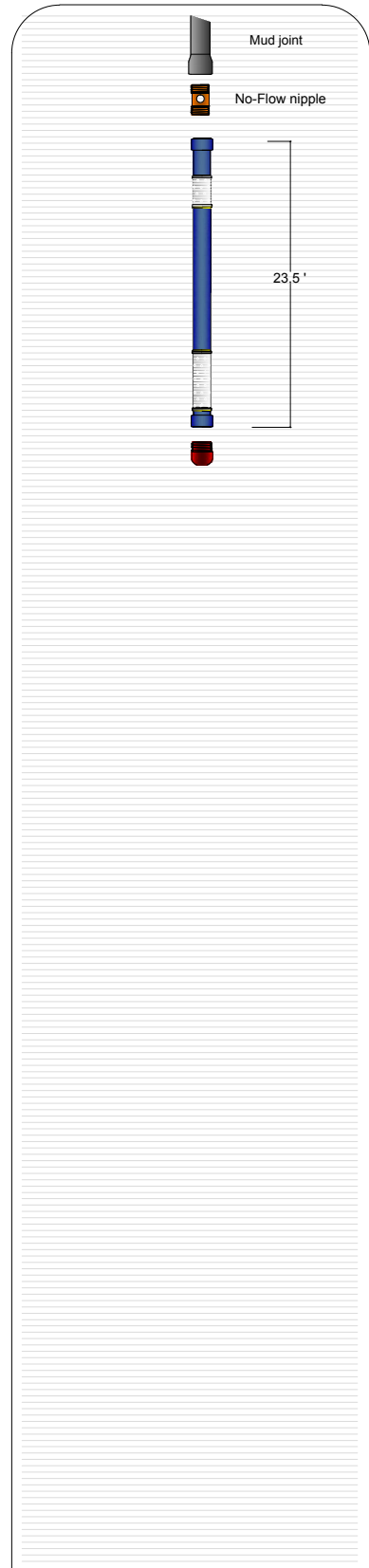
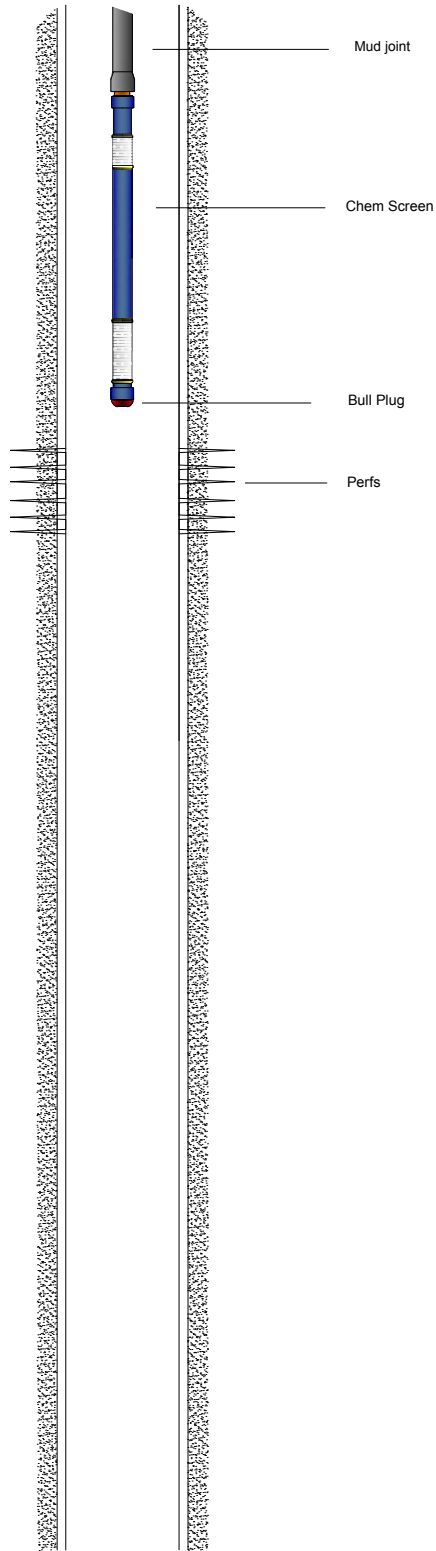

Company:
Field:
Well:

Config. 8.3.2 / Dual Body Super Gas & Sand Shield with
110' - Mud joint - Chem Screen- Bull Plug



Phone: +1 (432) 580-7111
Fax: +1 (432) 333-2015
1612 Viceroy • Odessa, TX 79763, US
ggonzalez@odessaseparator.com

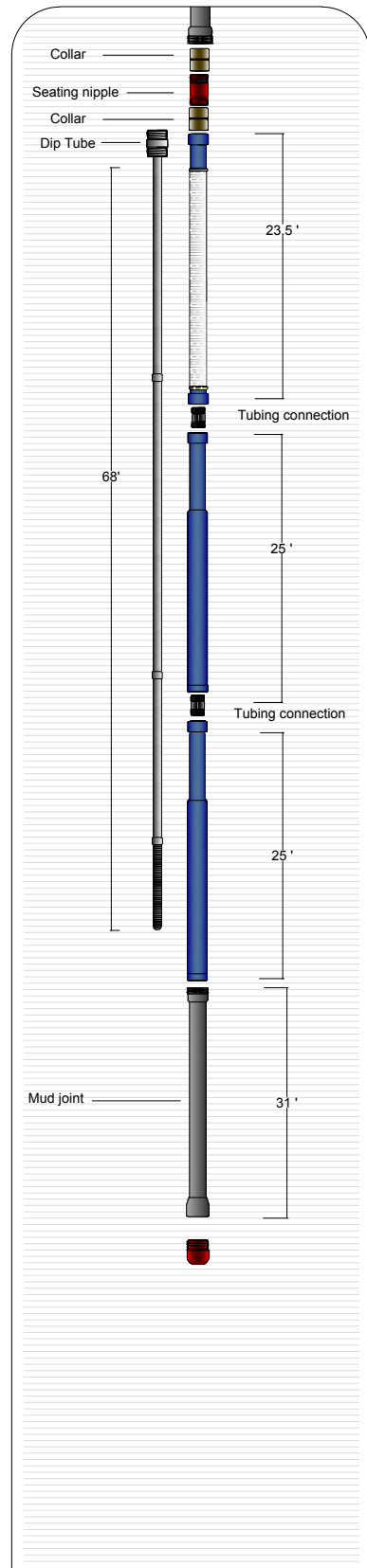
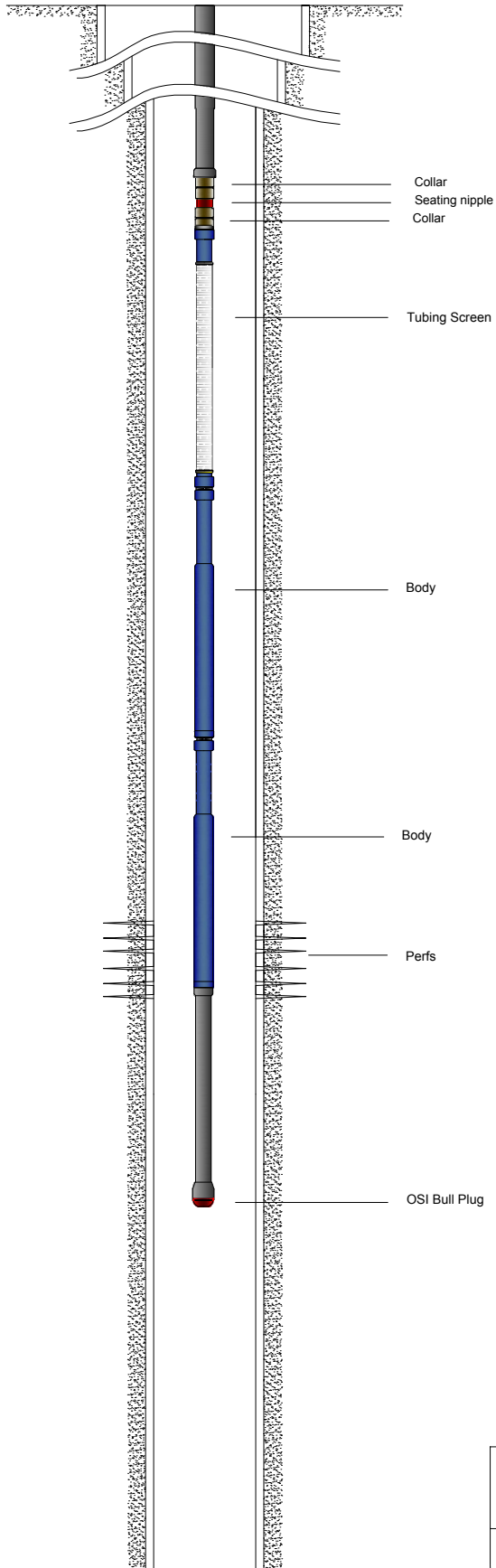

Company:
Field:
Well:

Config. 8.4 Dual Body Super Gas & Sand Shield with
68' Dip-Tube - 1 Mud joint - Bull Plug



Phone: +1 (432) 580-7111
Fax: +1 (432) 333-2015
1612 Viceroy • Odessa, TX 79763, US
ggonzalez@odsep.com

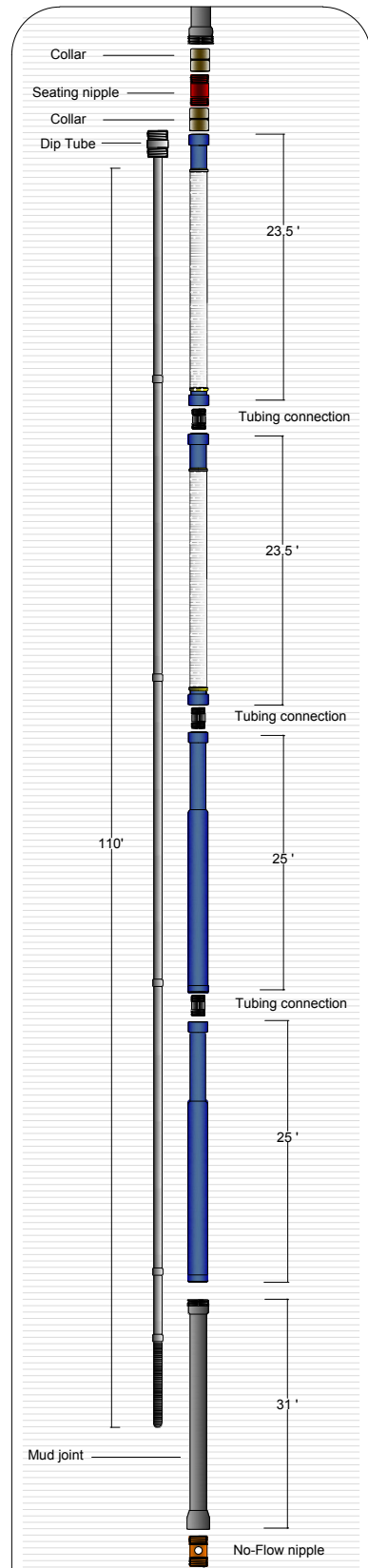
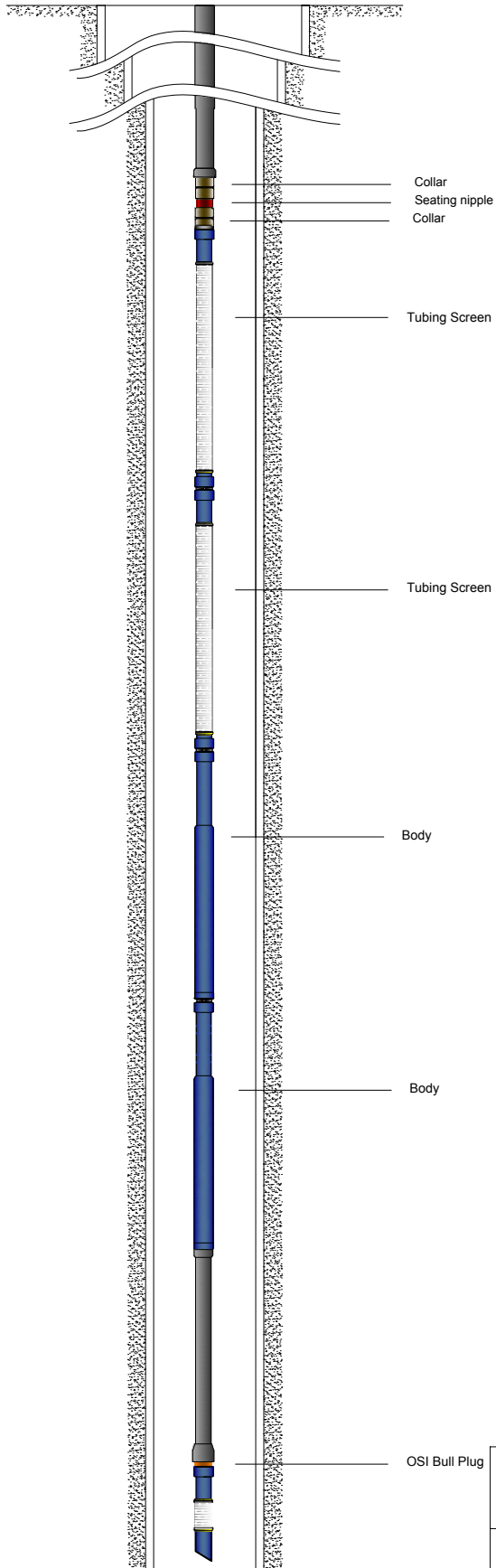

Company:
Field:
Well:

Config. 8.5.1 / Dual Body Super Gas & Sand Shield with
110' - Mud joint - Extended Chem Screen- Bull Plug



Phone: +1 (432) 580-7111
Fax: +1 (432) 333-2015
1612 Viceroy • Odessa, TX 79763, US
ggonzalez@odsep.com

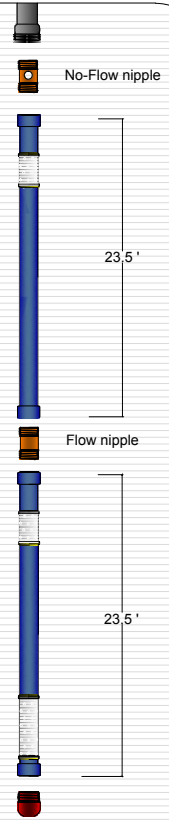
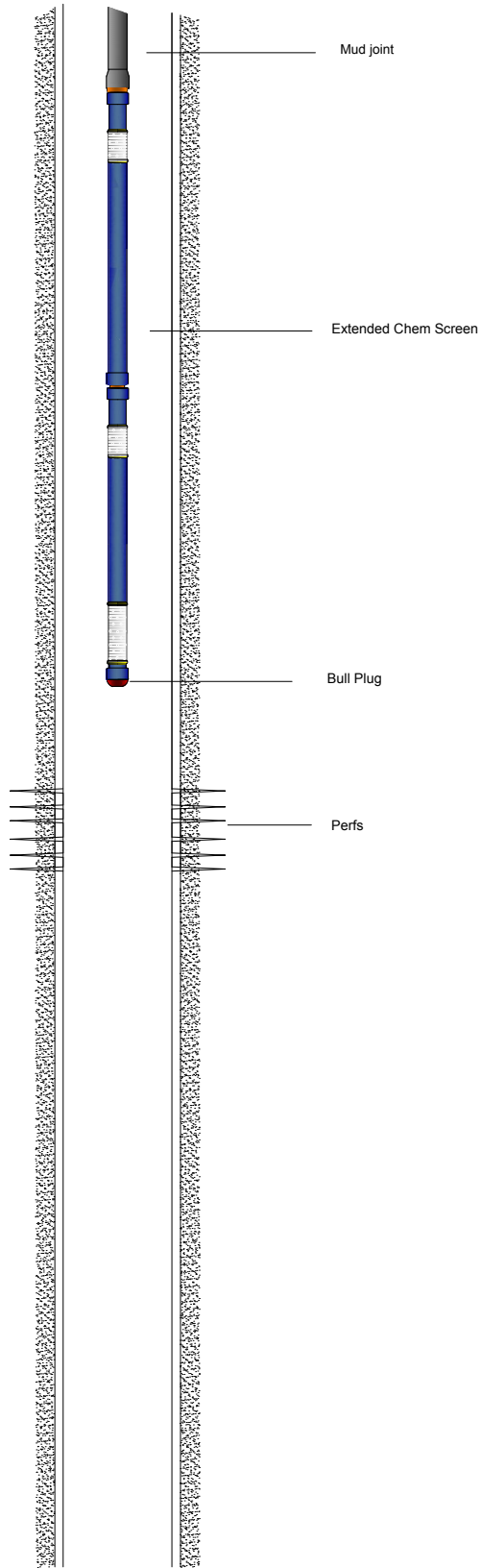

Company:
Field:
Well:

Config. 8.5.2 / Dual Body Super Gas & Sand Shield with
110' - Mud joint - Extended Chem Screen- Bull Plug



Phone: +1 (432) 580-7111
Fax: +1 (432) 333-2015
1612 Viceroy • Odessa, TX 79763, US
ggonzalez@odsep.com

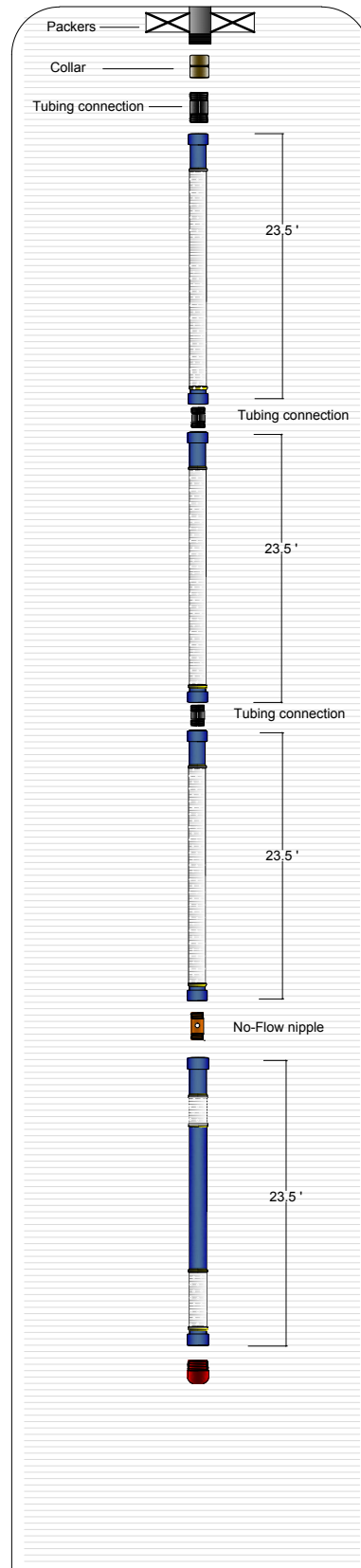
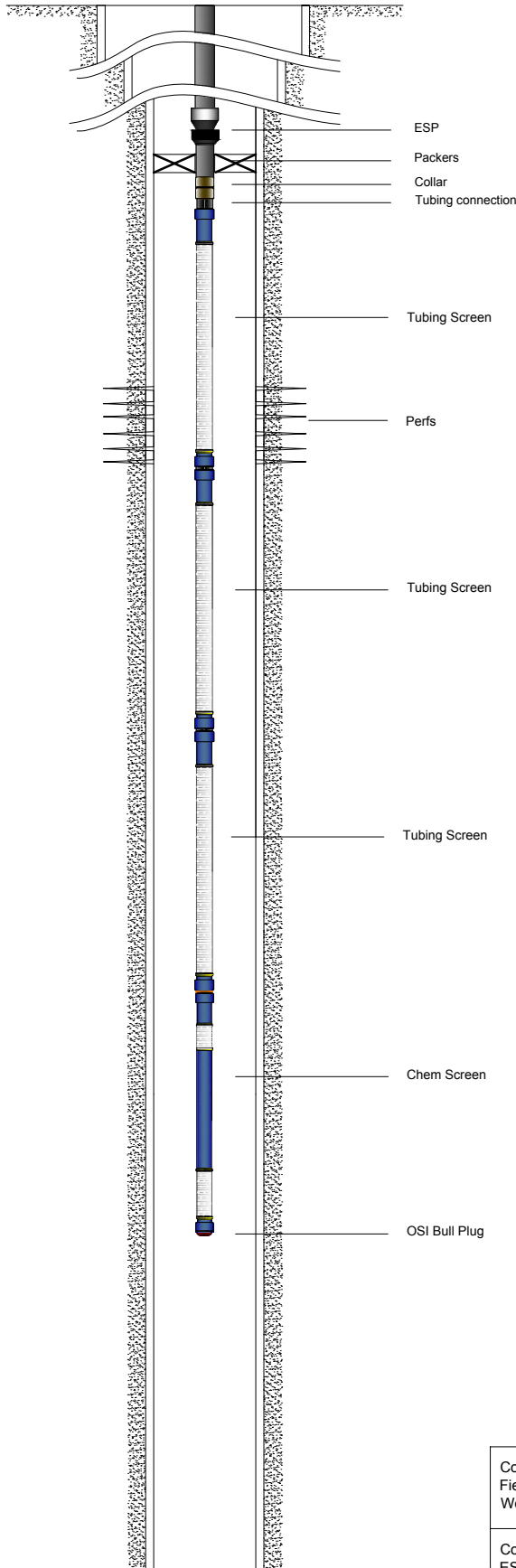

Company:
 Field:
 Well:

Config. 9.1 / Tubing Screen 3 - Chem Screen - Bull Plug - ESP

ODESSA
SEPARATOR, INC.

Phone: +1 (432) 580-7111
 Fax: +1 (432) 333-2015
 1612 Viceroy • Odessa, TX 79763, US
 ggonzalez@odessaseparator.com

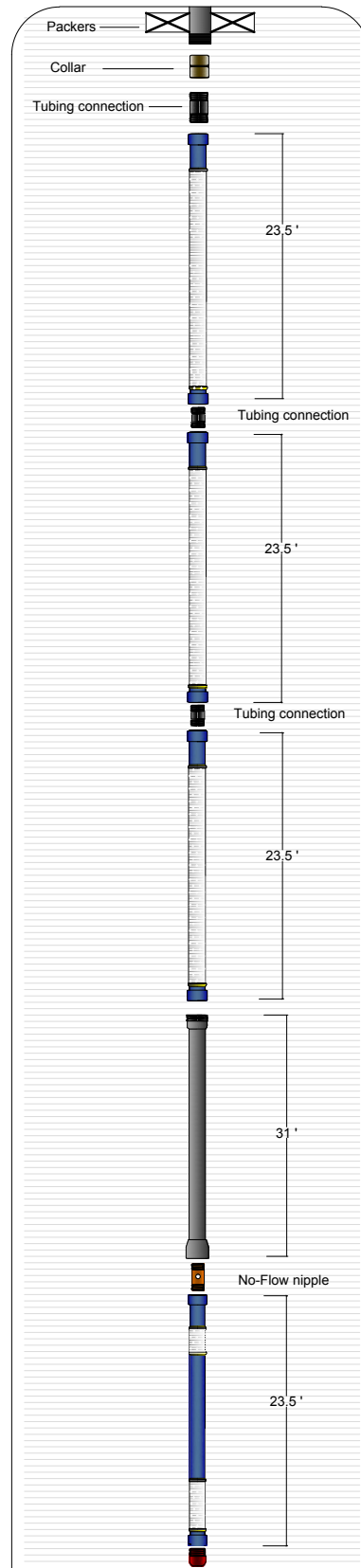
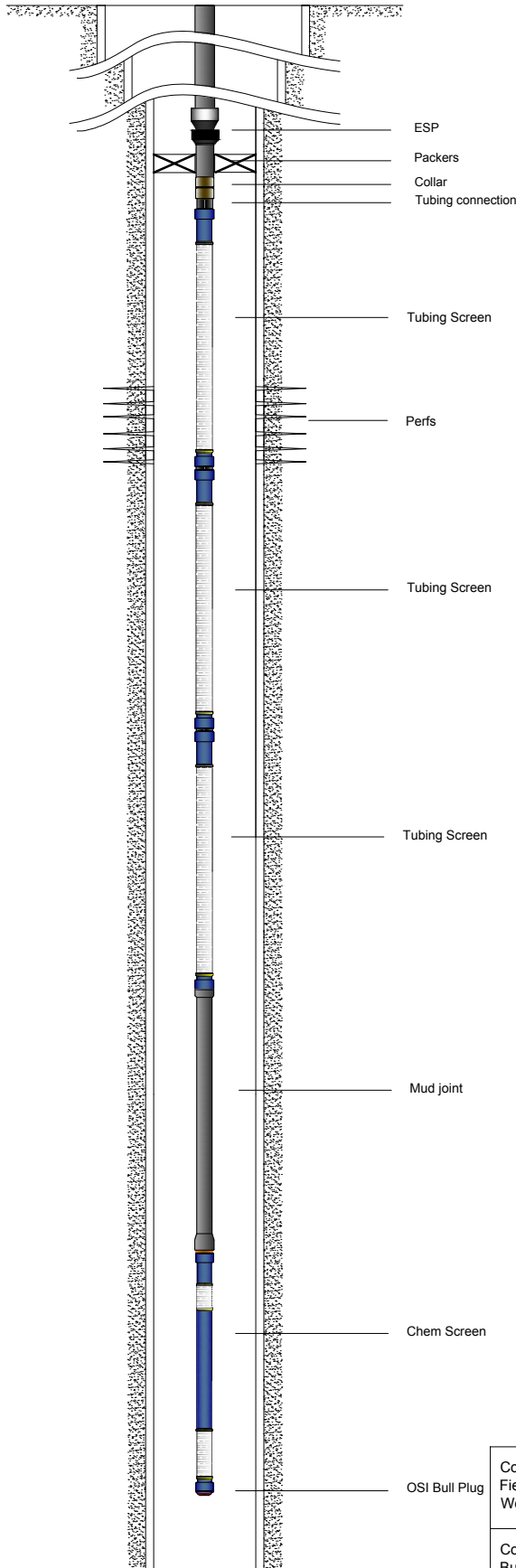

Company:
Field:
Well:

Config. 9.2 / Tubing Screen 3 - Mud joint - Chem Screen -
Bull Plug - ESP



Phone: +1 (432) 580-7111
Fax: +1 (432) 333-2015
1612 Viceroy • Odessa, TX 79763, US
ggonzalez@odessaseparator.com

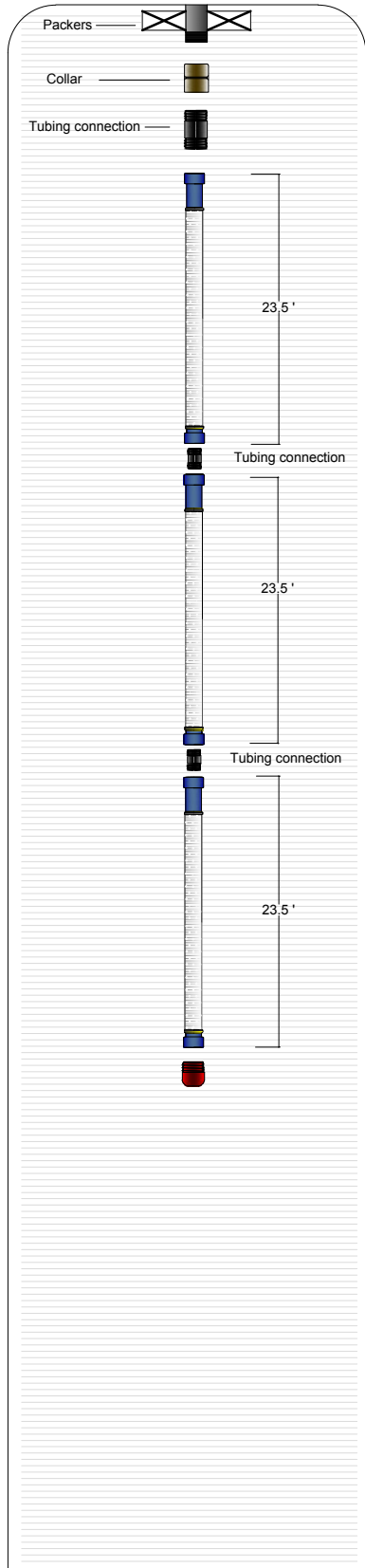
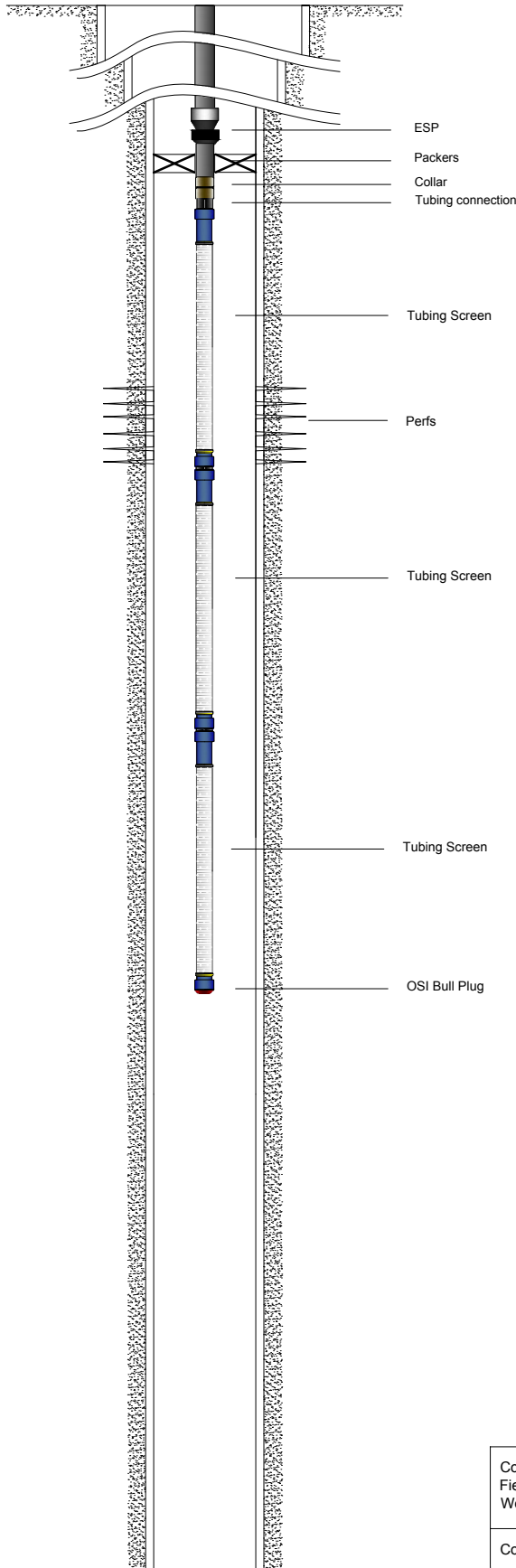

Company:
Field:
Well:

Config. 9.3 / Tubing Screen 3 - Bull Plug - ESP



Phone: +1 (432) 580-7111
Fax: +1 (432) 333-2015
1612 Viceroy • Odessa, TX 79763, US
ggonzalez@odessaseparator.com

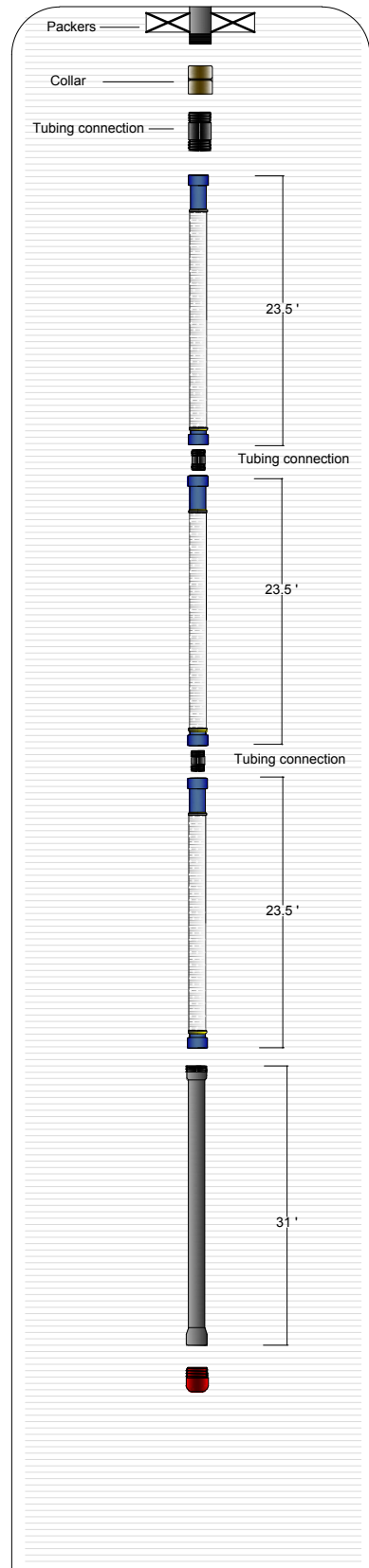
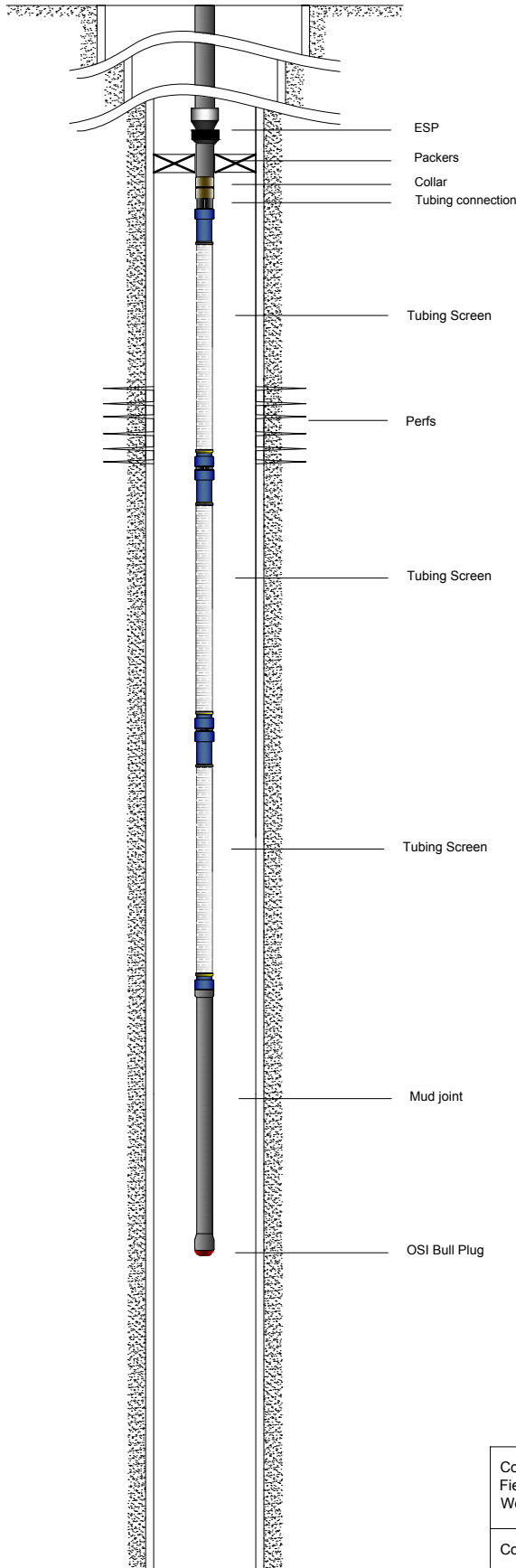

Company:
 Field:
 Well:

Config. 9.4 / Tubing Screen 3 - Mud joint - Bull Plug - ESP

ODESSA
SEPARATOR, INC.

Phone: +1 (432) 580-7111
 Fax: +1 (432) 333-2015
 1612 Viceroy • Odessa, TX 79763, US
 ggonzalez@odessaseparator.com

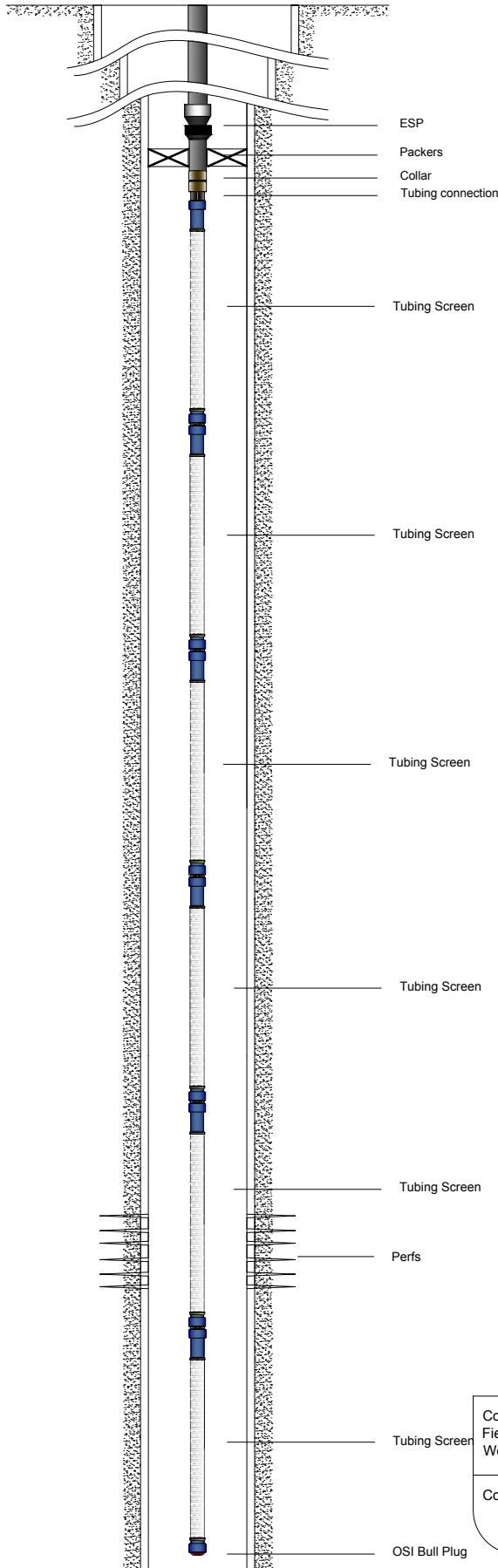

Company:
 Field:
 Well:

Config. 9.5 / Tubing Screen 6 - Bull Plug - ESP

ODESSA
SEPARATOR, INC.

Phone: +1 (432) 580-7111
 Fax: +1 (432) 333-2015
 1612 Viceroy • Odessa, TX 79763, US
 ggonzalez@odessaseparator.com

Assembly Above Packer

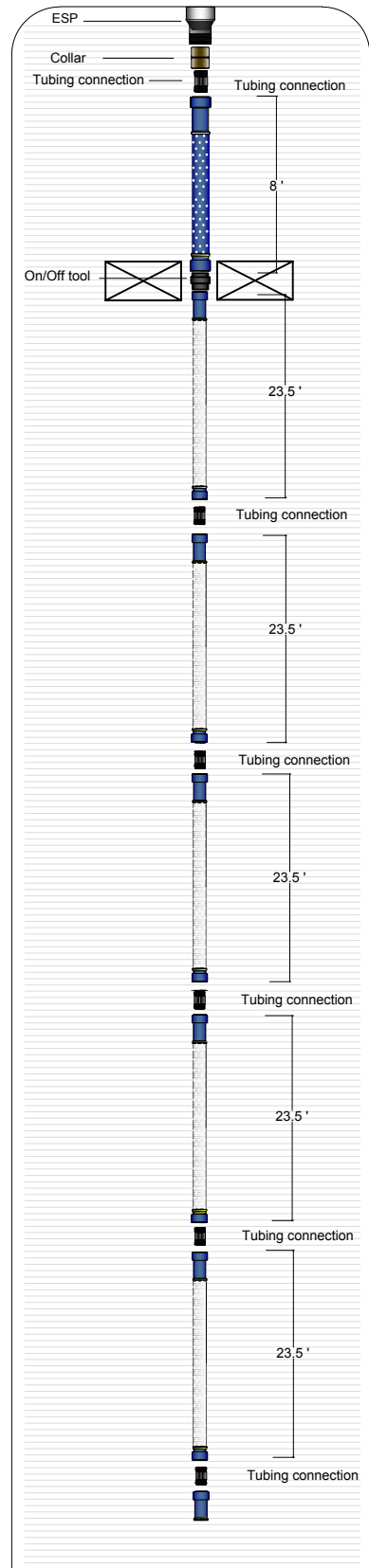
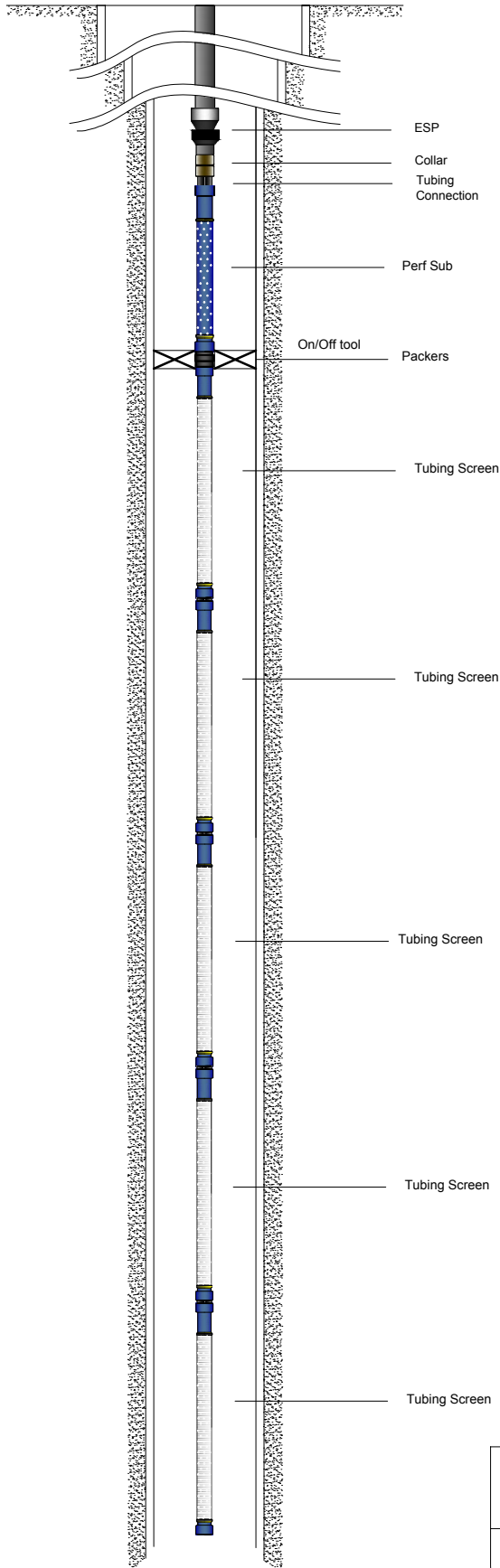

Company:
 Field:
 Well:

Config. 9.6.1 / ESP - Perf Sub -On/Off tool - Tubing
 Screen 10 - Bull Plug

ODESSA
SEPARATOR, INC.

Phone: +1 (432) 580-7111
 Fax: +1 (432) 333-2015
 1612 Viceroy • Odessa, TX 79763, US
 ggonzalez@odsep.com

Assembly Below Packer

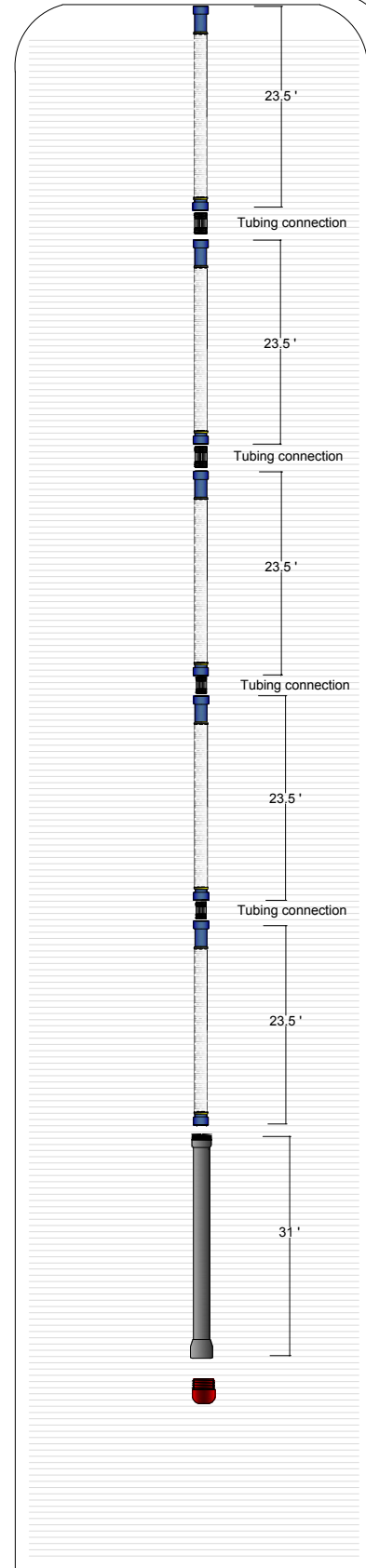
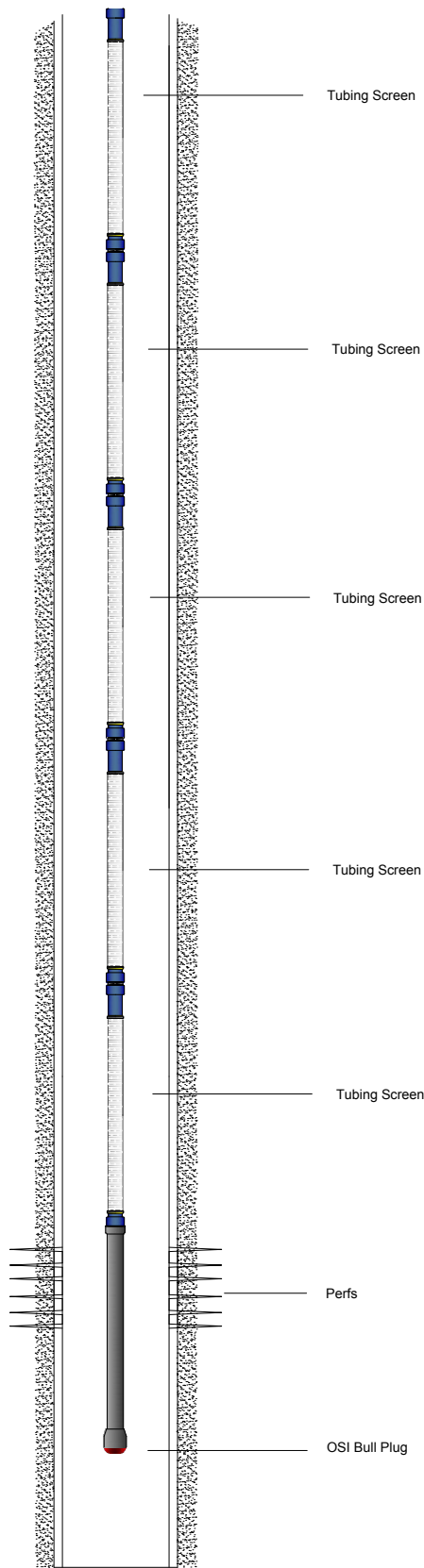

Company:
 Field:
 Well:

Config. 9.6.2 / ESP - Perf Sub - On/Off tool - Tubing
 Screen 10 - Bull Plug

ODESSA
SEPARATOR, INC.

Phone: +1 (432) 580-7111
 Fax: +1 (432) 333-2015
 1612 Viceroy • Odessa, TX 79763, US
 ggonzalez@odessaseparator.com

Assembly Above Packer

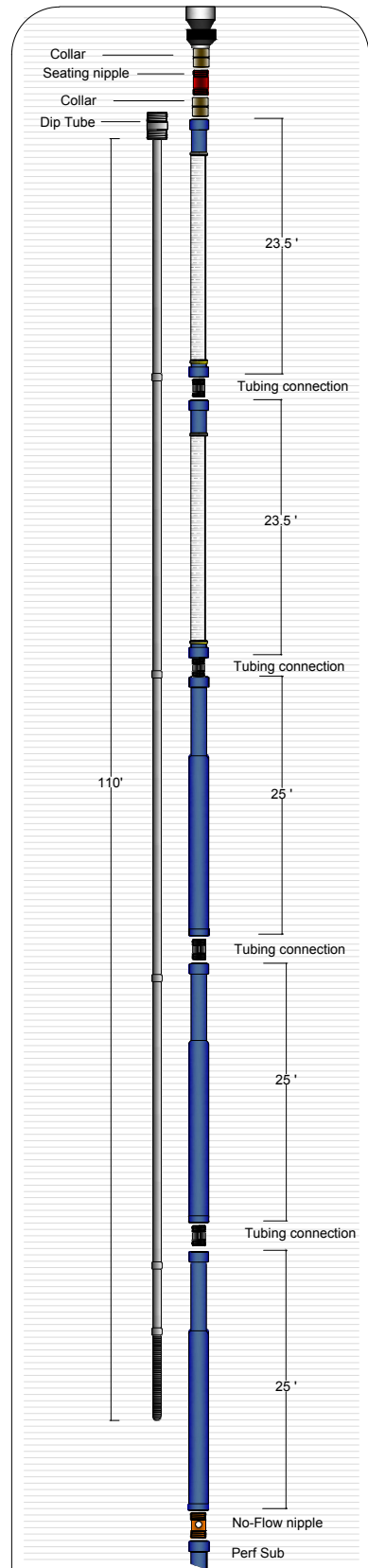
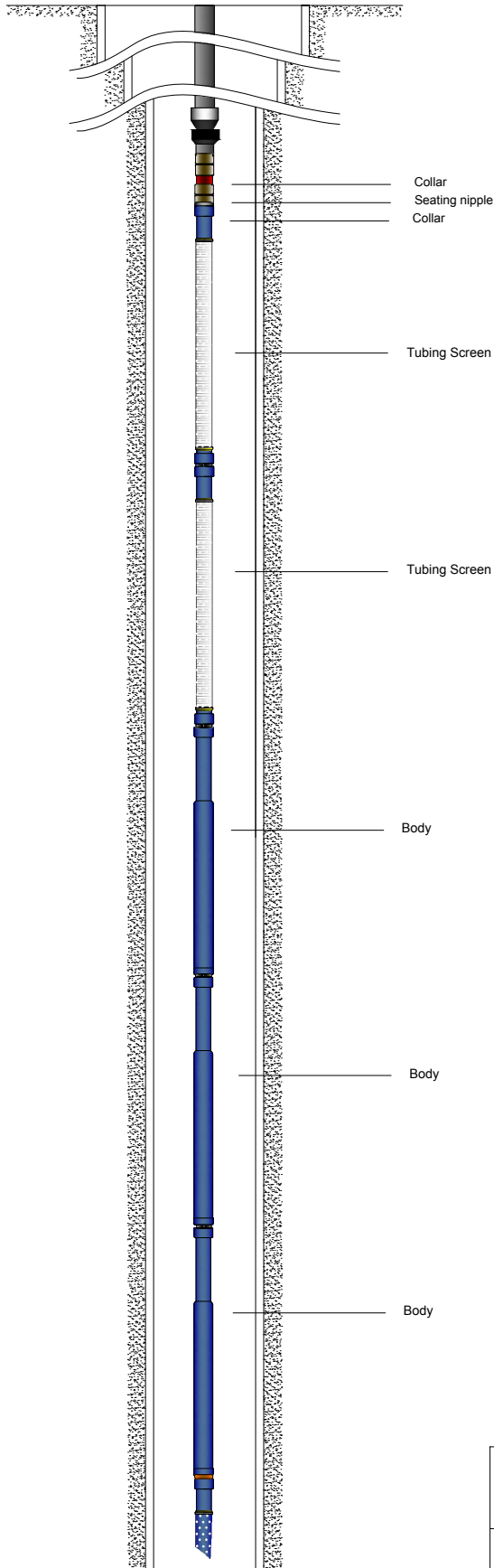

Company:
Field:
Well:

Config. 9.7.1 / TS 2- Dual body 3 with 110' - Perf Sub -
Packers - Desander - Mud joint 2 - Bull Plug



Phone: +1 (432) 580-7111
Fax: +1 (432) 333-2015
1612 Viceroy • Odessa, TX 79763, US
ggonzalez@odessaseparator.com

Assembly Below Packer

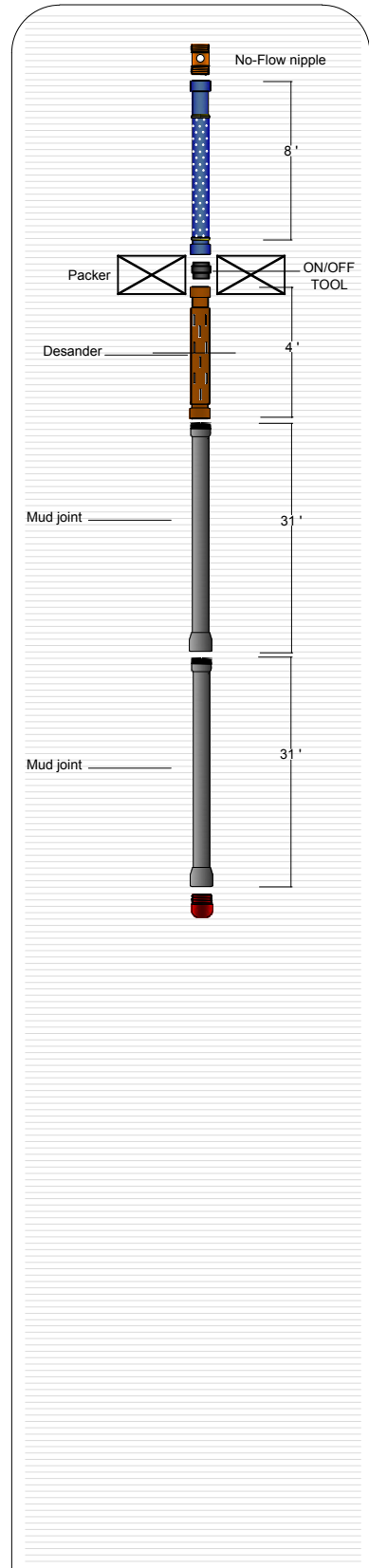
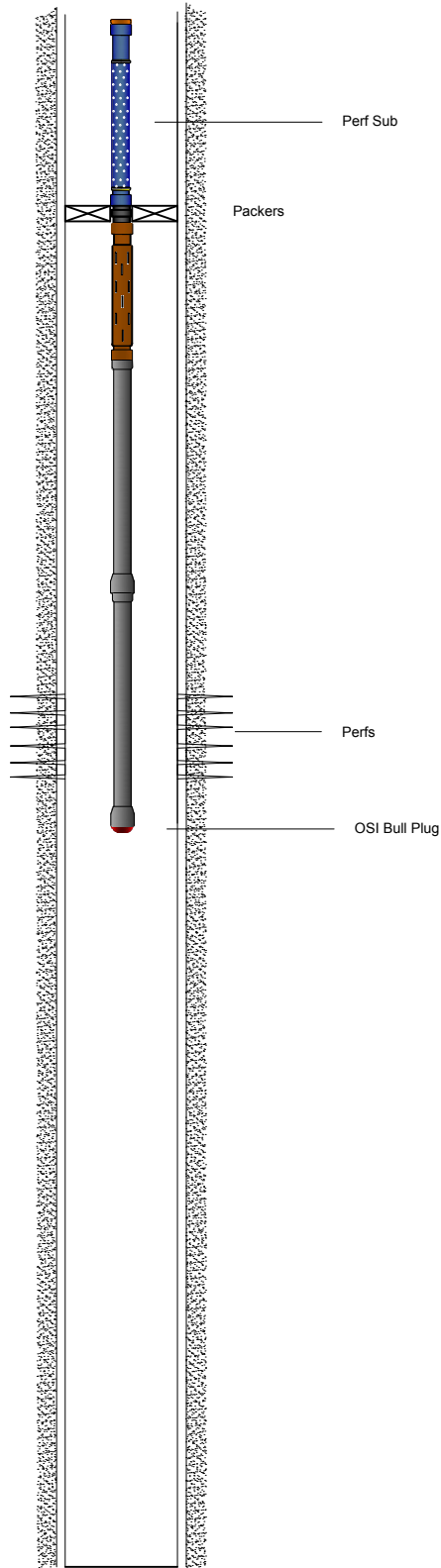

Company:
Field:
Well:

Config. 9.7.2 / TS 2- Dual body 3 with 110' - Perf Sub -
Packers - Desander - Mud joint 2 - Bull Plug



Phone: +1 (432) 580-7111
Fax: +1 (432) 333-2015
1612 Viceroy • Odessa, TX 79763, US
ggonzalez@odessaseparator.com

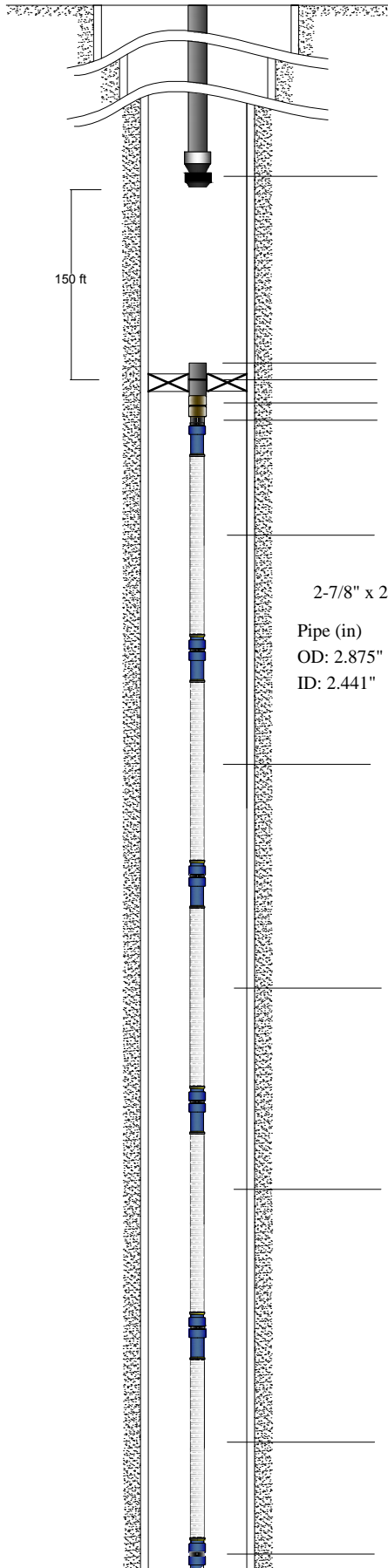

ESP

150 ft

On/Off Tool Packers
Seating Nipple
Tubing connection

Tubing Screen

2-7/8" x 23.5' x 10 Slot (Qty 8)

Pipe (in)	Screen (in)	Collar (in)
OD: 2.875"	OD: 3.370"	OD: 3.668"
ID: 2.441"		ID: 2.875"

Tubing Screen

Tubing Screen

Tubing Screen

Tubing Screen

ESP

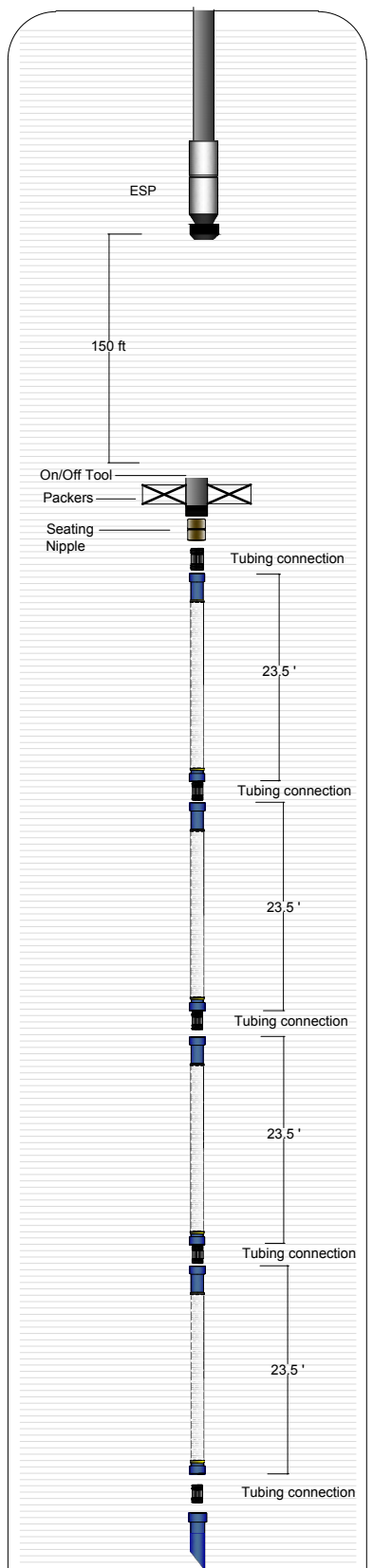

ESP

150 ft

On/Off Tool Packers
Seating Nipple

Tubing connection

23.5'

Tubing connection

23.5'

Tubing connection

23.5'

Tubing connection

23.5'

Tubing connection

Company:
Field:
Well:

Config. 9.8.1 / ESP - Perf Sub -On/Off tool - Tubing Screen 8 - Mud joint - Bull Plug

Phone: +1 (432) 580-7111
Fax: +1 (432) 333-2015
1612 Viceroy • Odessa, TX 79763, US
ggonzalez@odsep.com

Assembly Below Packer (Page 2)

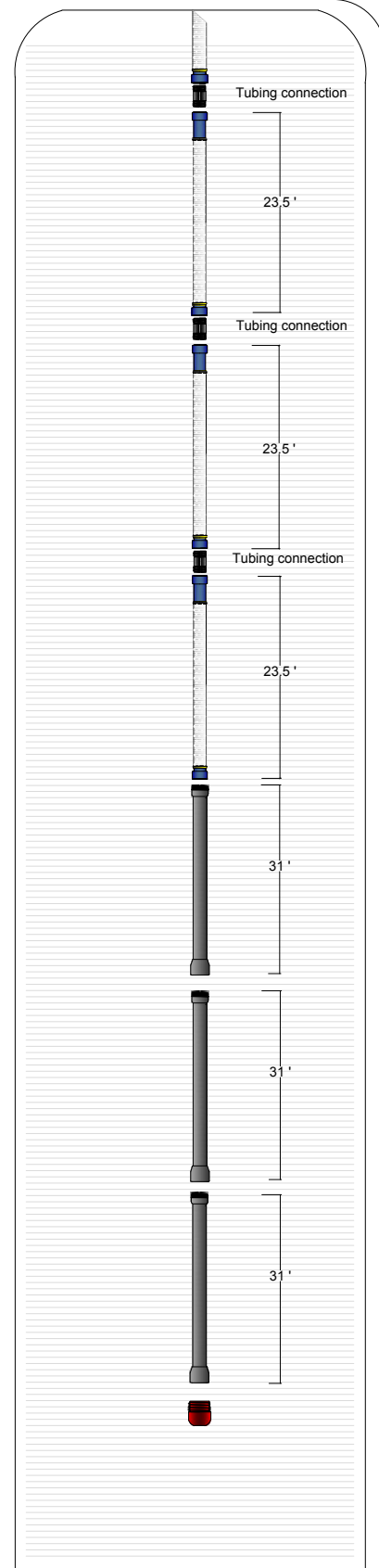
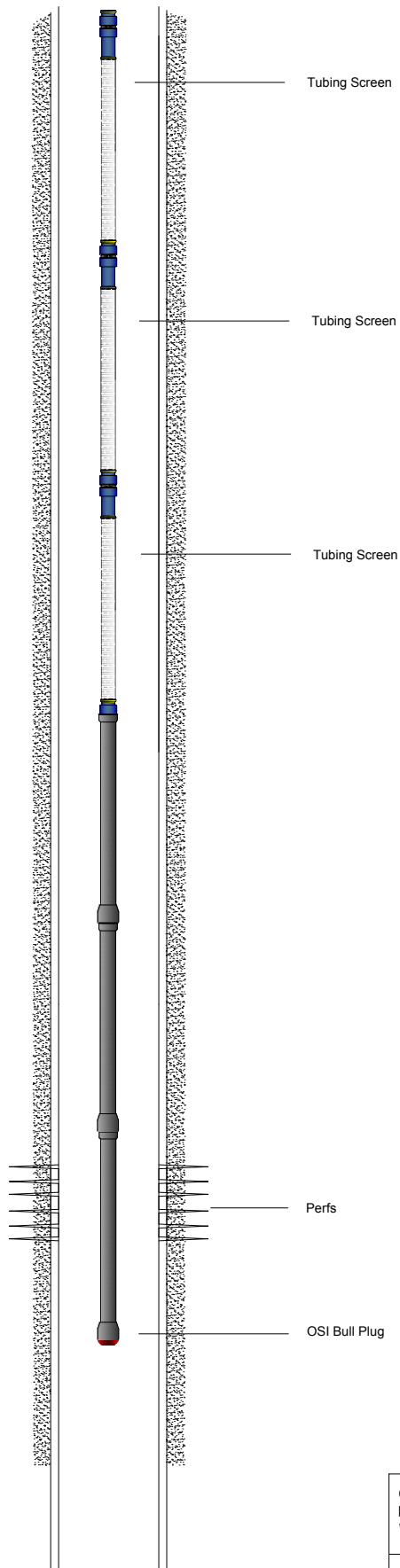

Company:
 Field:
 Well:

Config. 9.8.2 / ESP - Perf Sub -On/Off tool - Tubing
 Screen 8 - Mud joint - Bull Plug

ODESSA
SEPARATOR, INC.

Phone: +1 (432) 580-7111
 Fax: +1 (432) 333-2015
 1612 Viceroy • Odessa, TX 79763, US
 ggonzalez@odsep.com

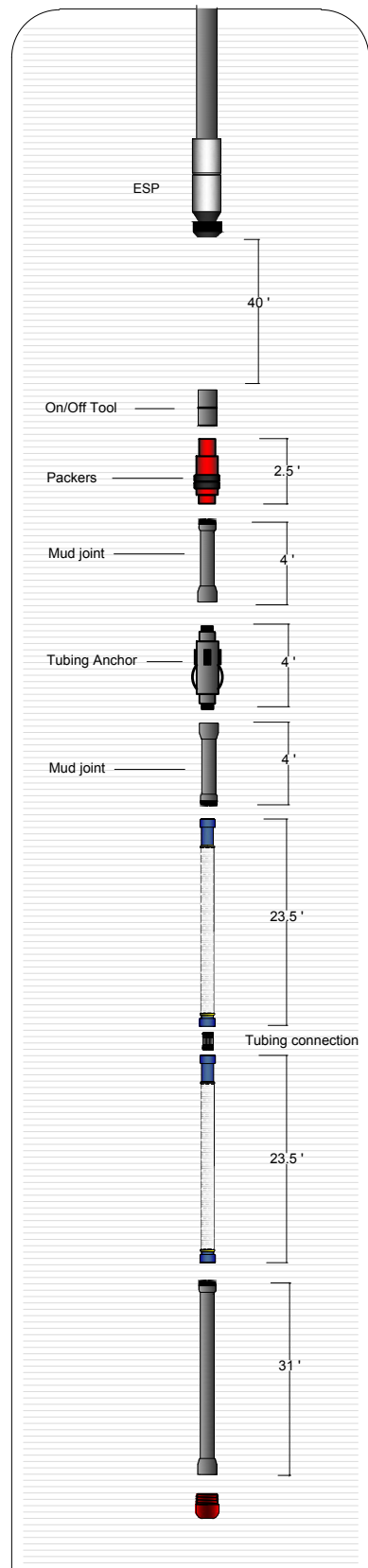
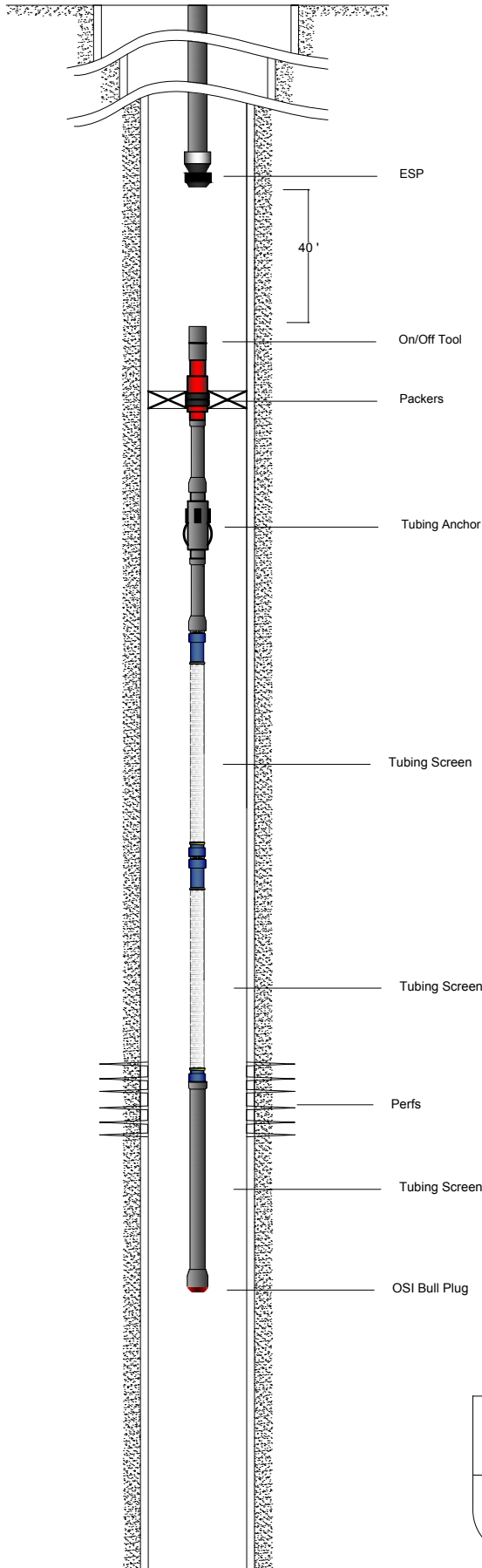

Company:
Field:
Well:

Config. 9.9.1 / ESP - On/Off tool - Packer CRP - Pup joint -
Tubing Anchor - Pup joint - Tubing Screen - Mud joint -
Bull Plug



Phone: +1 (432) 580-7111
Fax: +1 (432) 333-2015
1612 Viceroy • Odessa, TX 79763, US
ggonzalez@odsep.com

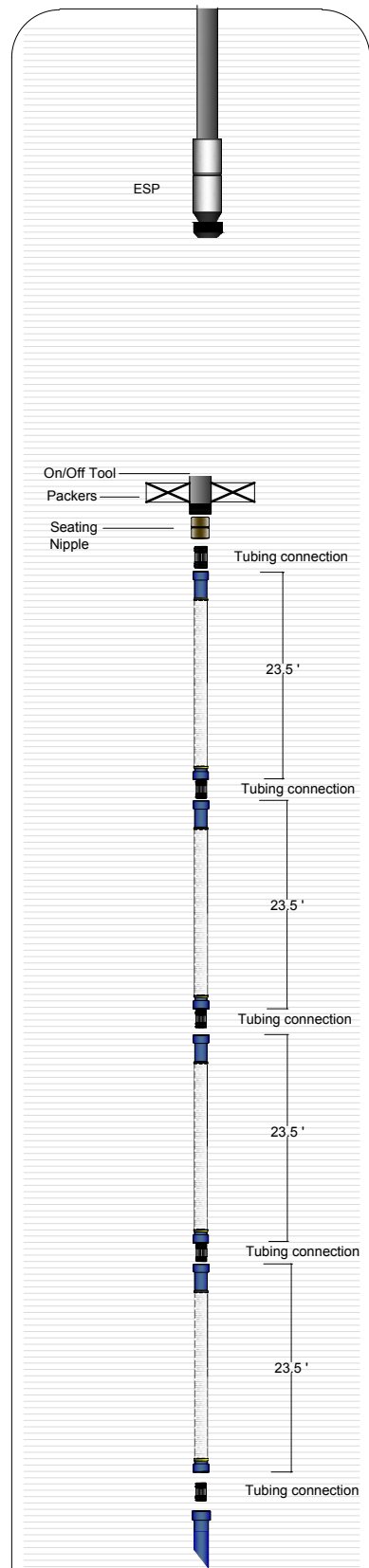
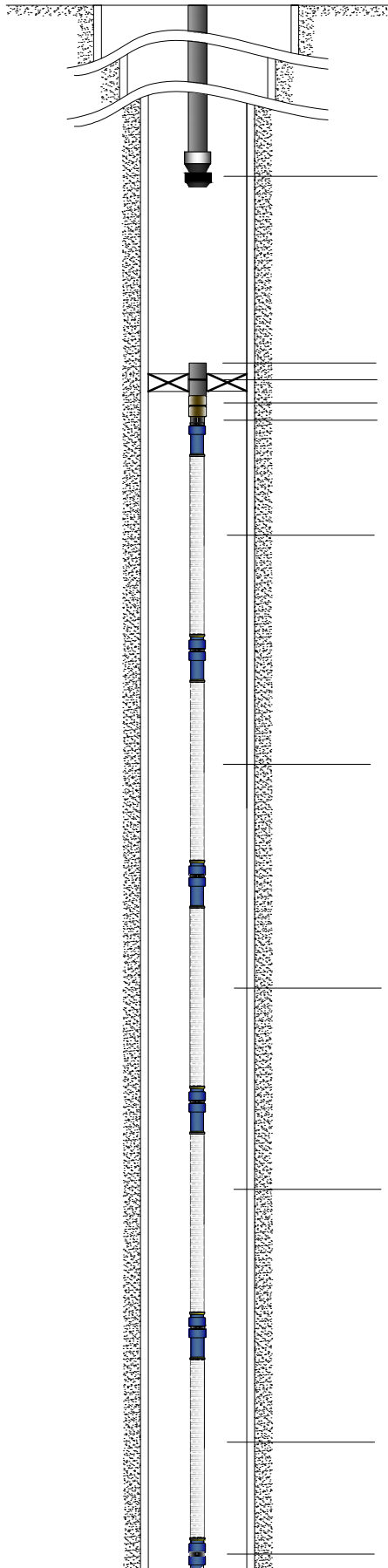

Company:
 Field:
 Well:

Config. 9 5/8" / ESP - On/Off tool - Packer - Tubing Screen 9 - Mud joint 2- Bull Plug

ODESSA
SEPARATOR, INC.

Phone: +1 (432) 580-7111
 Fax: +1 (432) 333-2015
 1612 Viceroy • Odessa, TX 79763, US
 ggonzalez@odsep.com

Assembly Below Packer (Page 2)

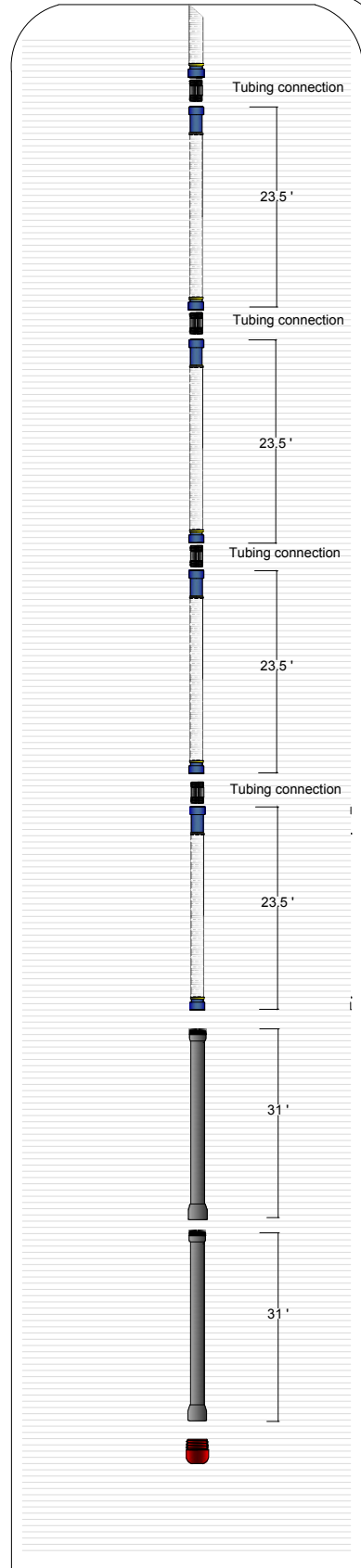
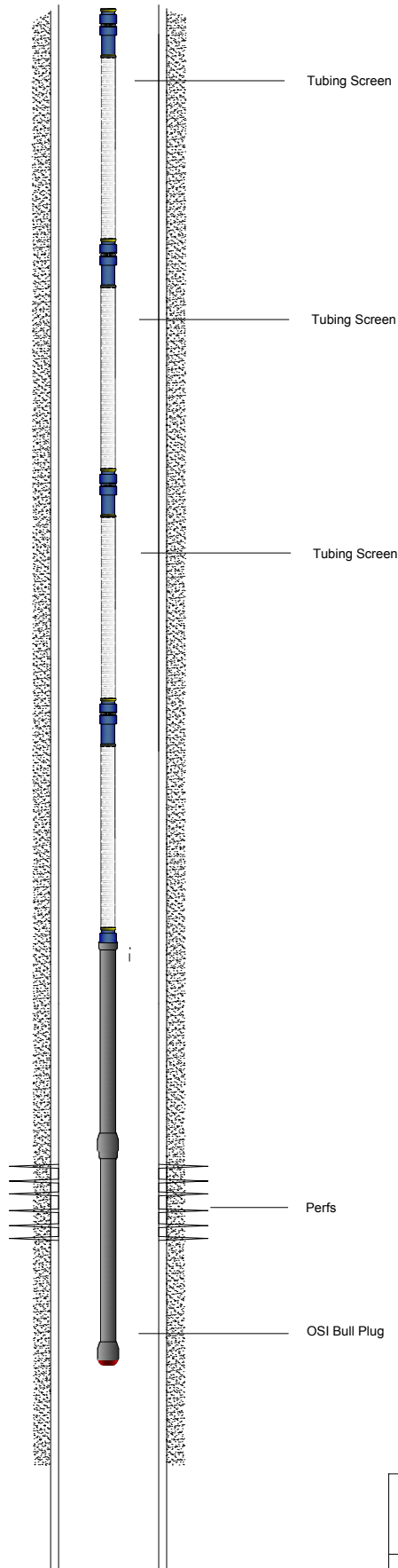

Company:
Field:
Well:

Config. 9#-62 / ESP - On/Off tool - Packer - Tubing
Screen 9 - Mud joint 2- Bull Plug



Phone: +1 (432) 580-7111
Fax: +1 (432) 333-2015
1612 Viceroy • Odessa, TX 79763, US
ggonzalez@odsep.com

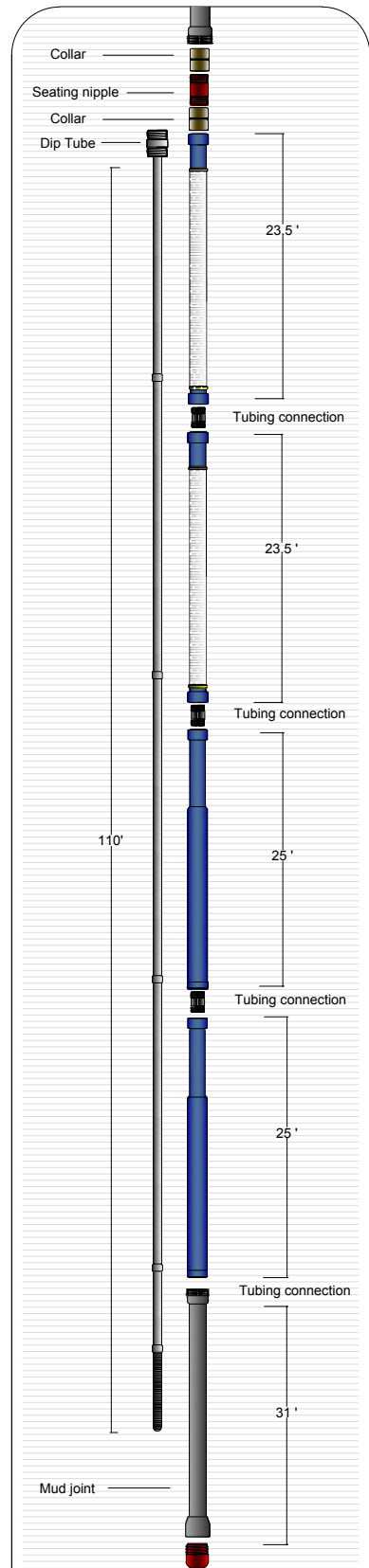
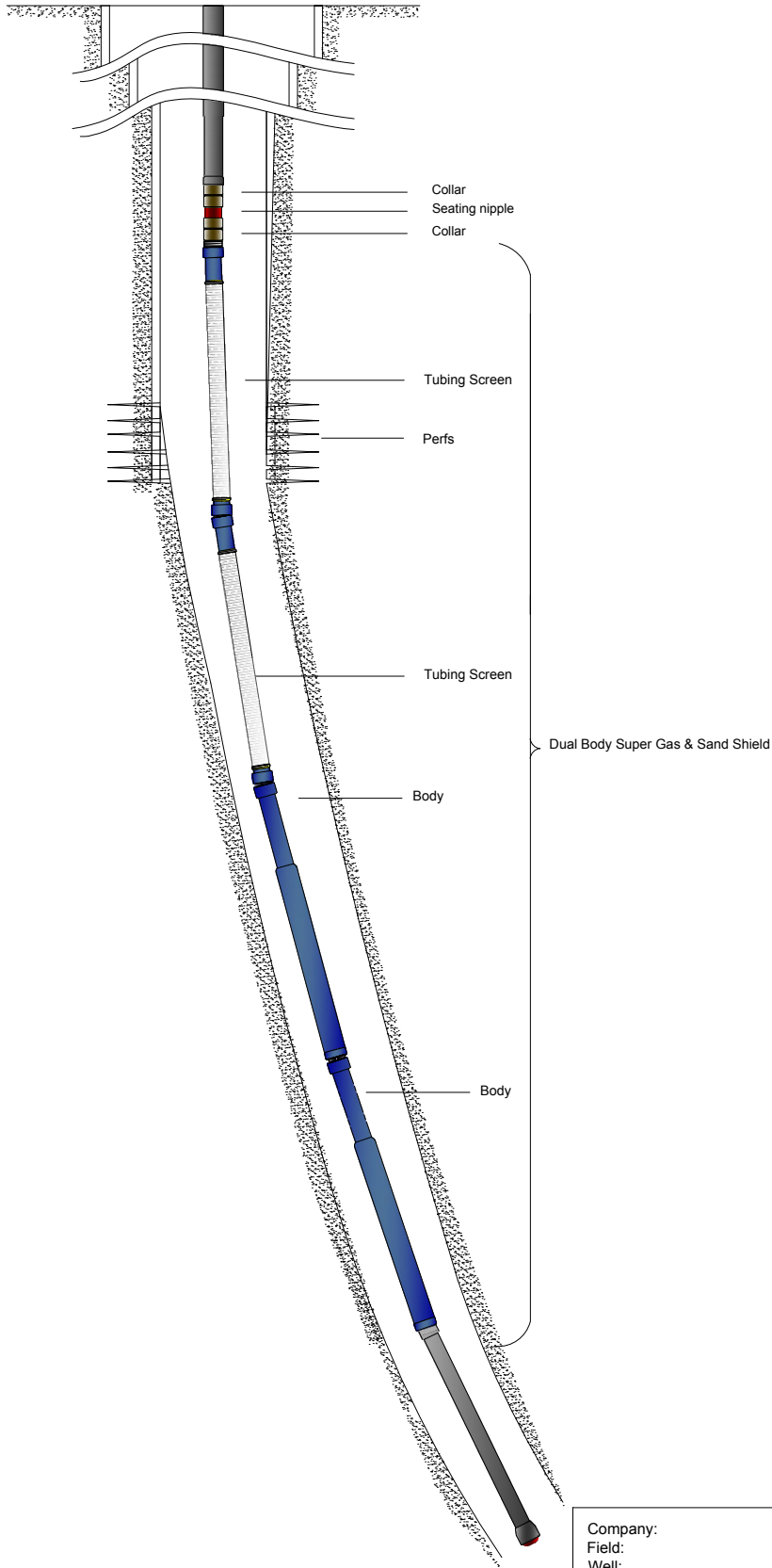

Company:
Field:
Well:

Config. 10.1 / Dual Body Super Gas & Sand Shield 110 Ft Dip-Tube- Mud joint - Bull Plug



Phone: +1 (432) 580-7111
Fax: +1 (432) 333-2015
1612 Viceroy • Odessa, TX 79763, US
ggonzalez@odessaseparator.com

Assembly Above Packer

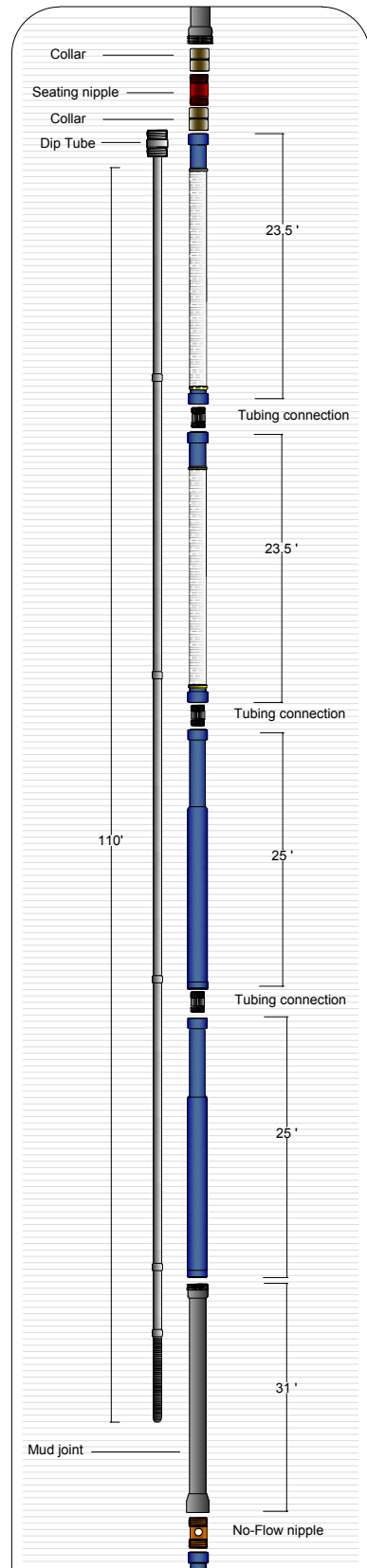
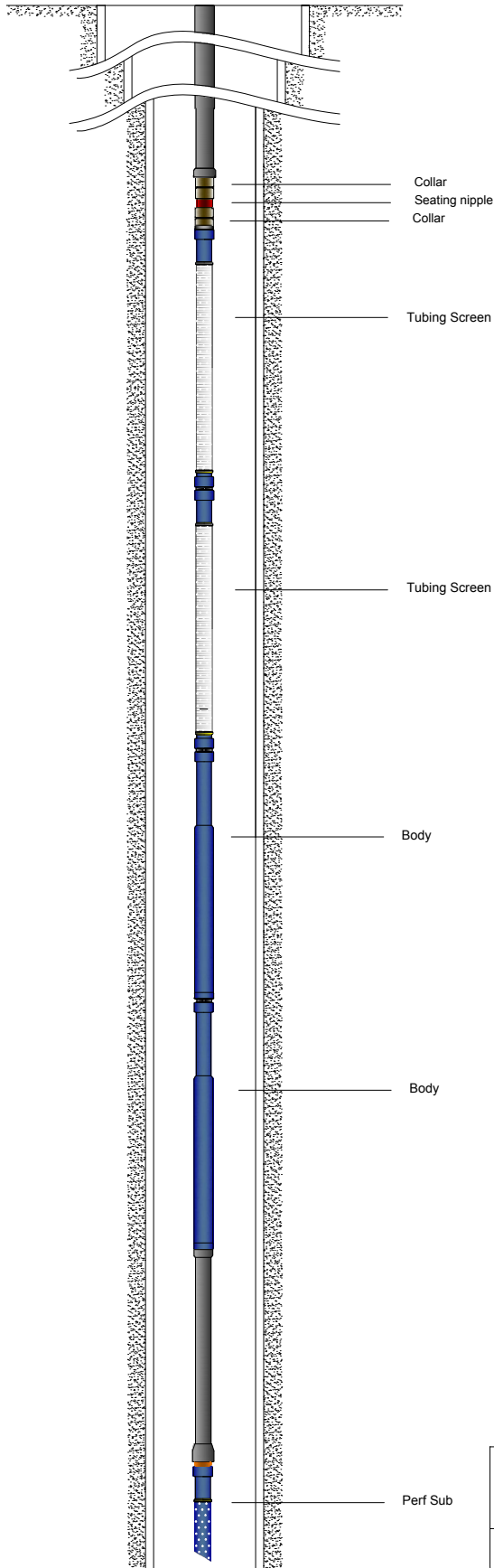

Company:
Field:
Well:

Config. 11.1.1 / Dual Body Super Gas & Sand Shield with
110' - Mud joint - Perf Sub



Phone: +1 (432) 580-7111
Fax: +1 (432) 333-2015
1612 Viceroy • Odessa, TX 79763, US
ggonzalez@odessaseparator.com

Assembly Below Packer

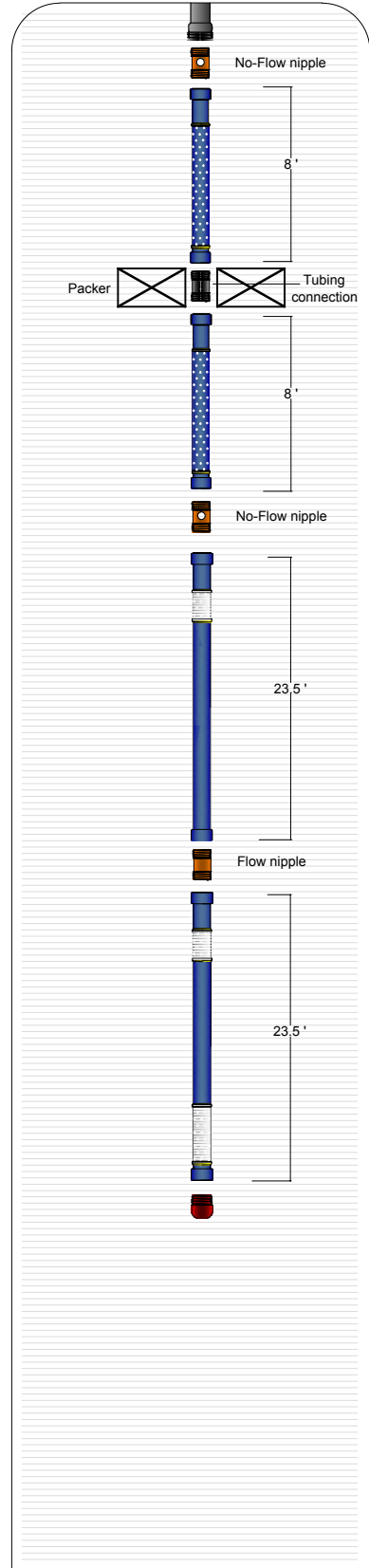
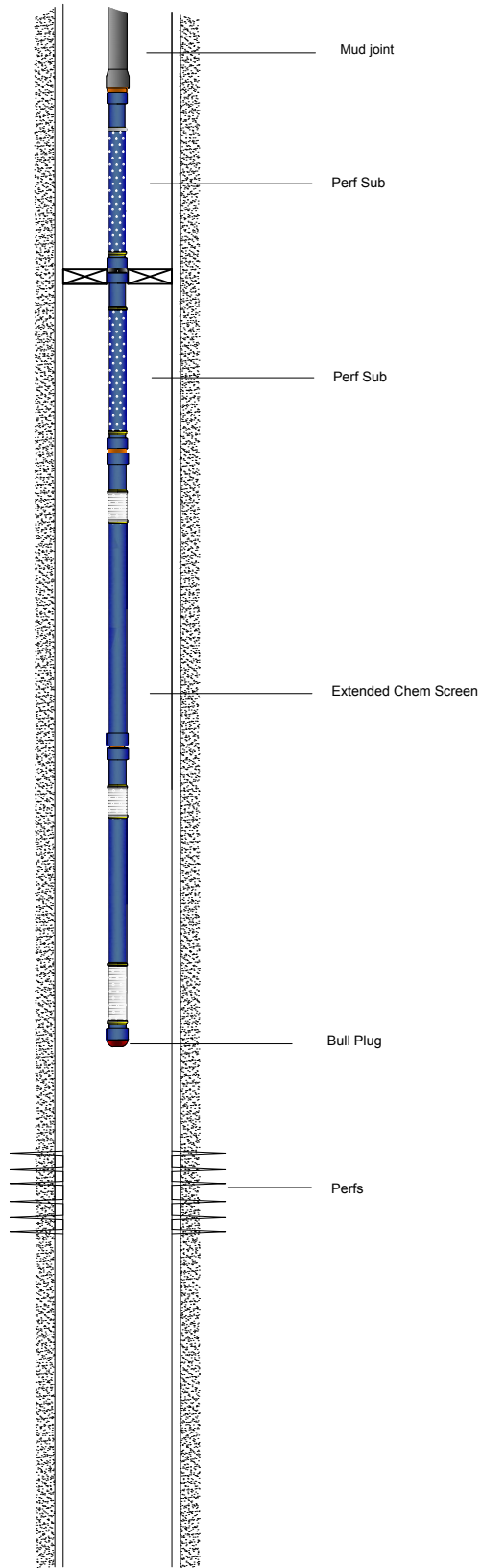

Company:
 Field:
 Well:

Config. 11.1.2 / Mud Joint - Perf Sub 8' (2) - Ext. Chem Screen- Bull Plug with packer.

Phone: +1 (432) 580-7111
 Fax: +1 (432) 333-2015
 1612 Viceroy • Odessa, TX 79763, US
 ggonzalez@odessaseparator.com

Assembly Above Packer

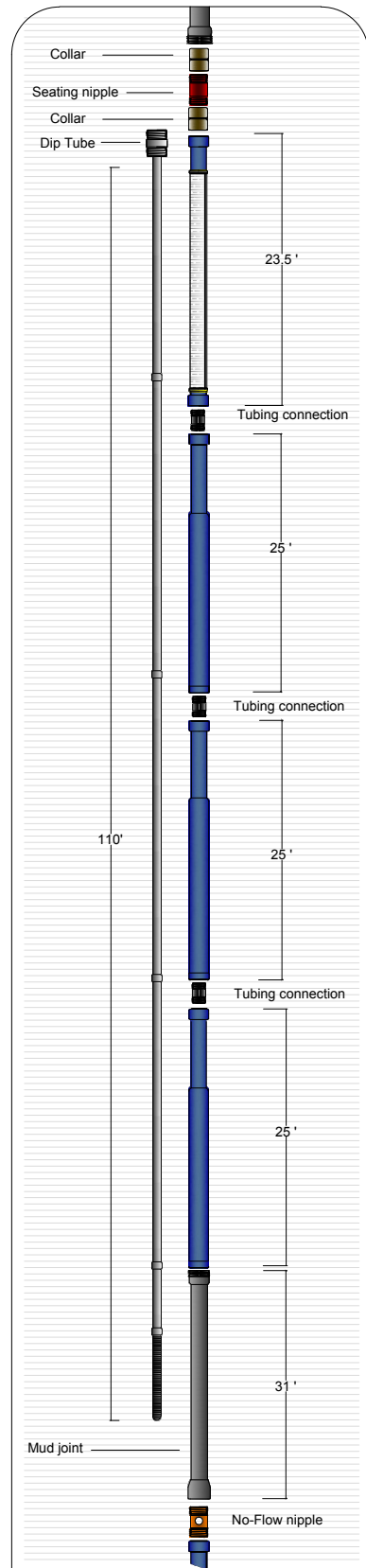
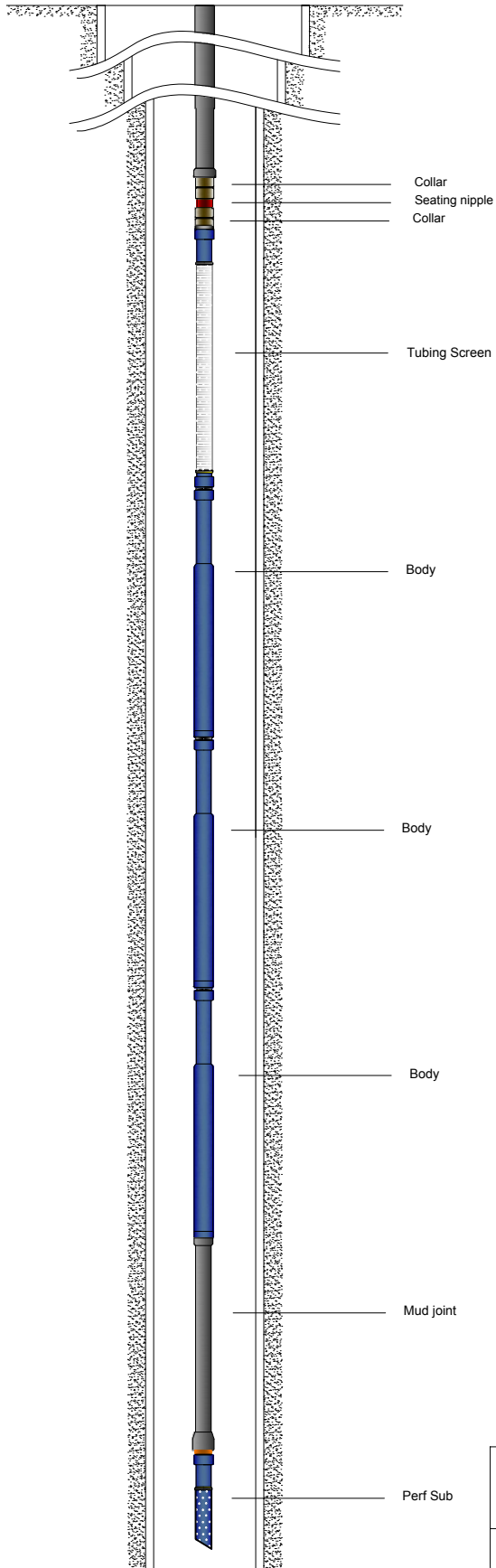

Company:
Field:
Well:

Config. 11.2.1 / TS 1- Dual body 3 with 110' - Mud joint -
Perf Sub - TS 2 - Ext. Chem Screen



Phone: +1 (432) 580-7111
Fax: +1 (432) 333-2015
1612 Viceroy • Odessa, TX 79763, US
ggonzalez@odessaseparator.com

Assembly Below Packer

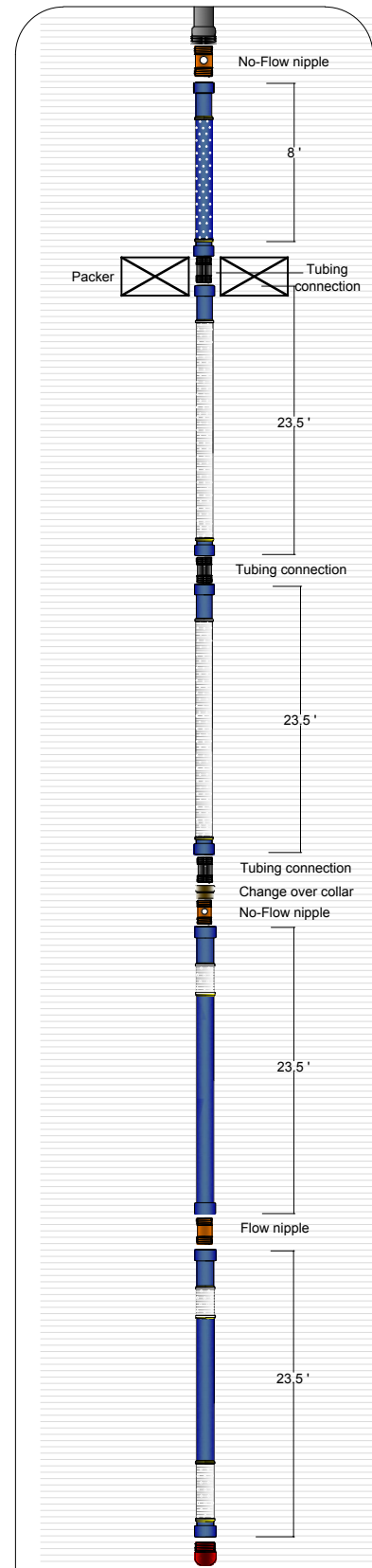
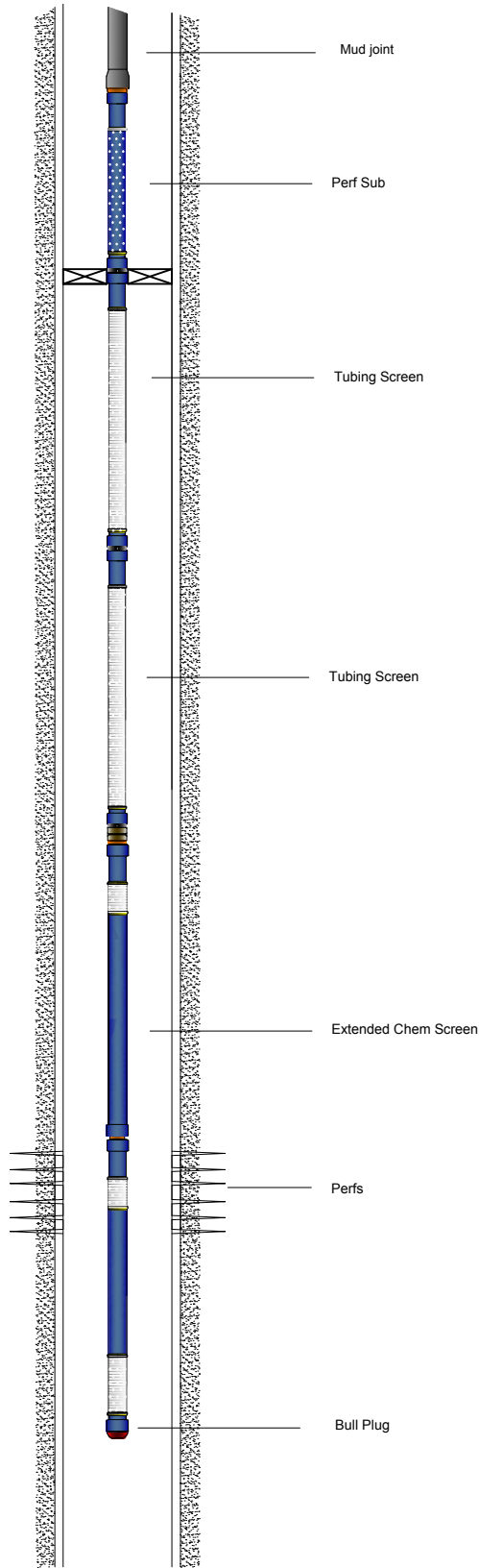

Company:
Field:
Well:

Config. 11.2.2 / Mud Joint - Perf Sub 8' - TS 2 - Ext. Chem Screen- Bull Plug with packer.



Phone: +1 (432) 580-7111
Fax: +1 (432) 333-2015
1612 Viceroy • Odessa, TX 79763, US
ggonzalez@odessaseparator.com

Assembly Above Packer

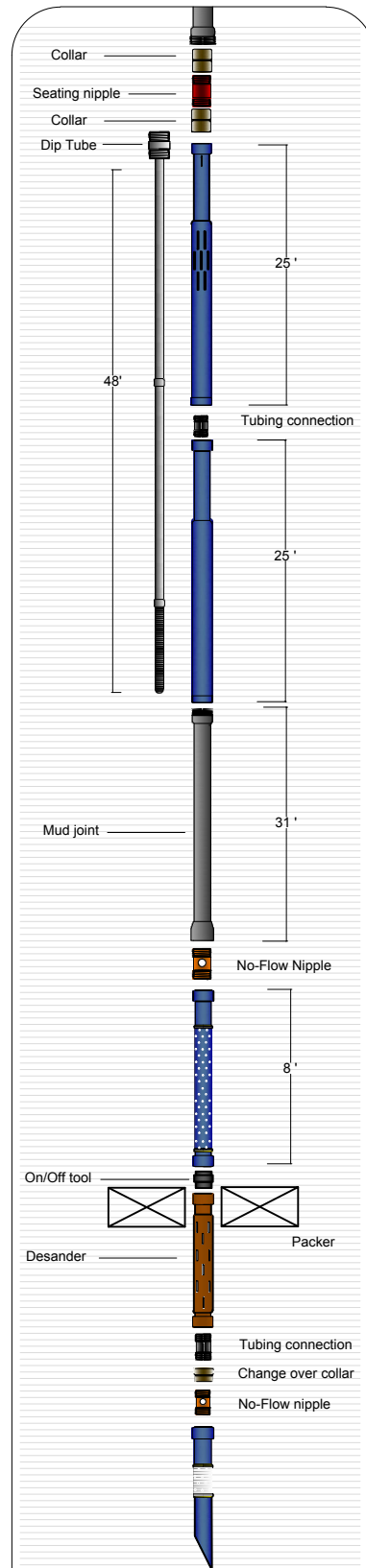
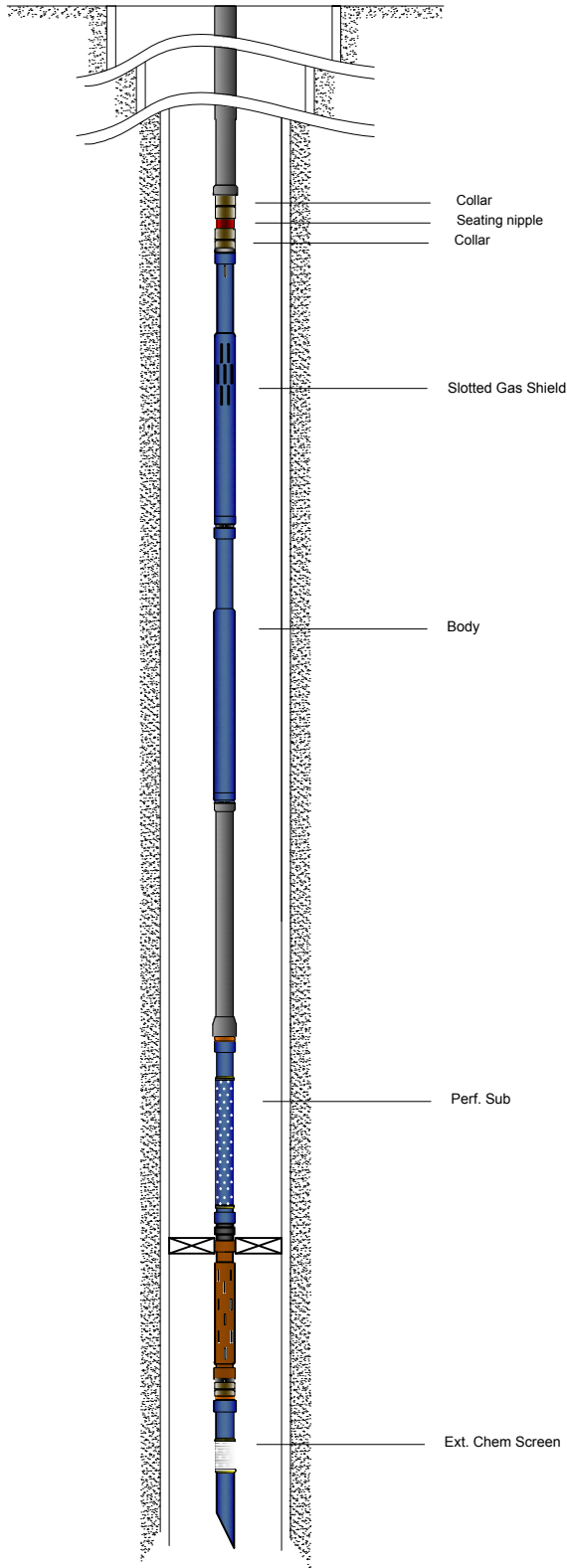

Company:
Field:
Well:

Config. 11.3.1 / SGS W/BODY 48' Dip-Tube - MJ - PS -
ON/OFF Tool - Packer - Desander - EXT. CS



Phone: +1 (432) 580-7111
Fax: +1 (432) 333-2015
1612 Vicerooy • Odessa, TX 79763, US
ggonzalez@odessaseparator.com

Assembly Below Packer

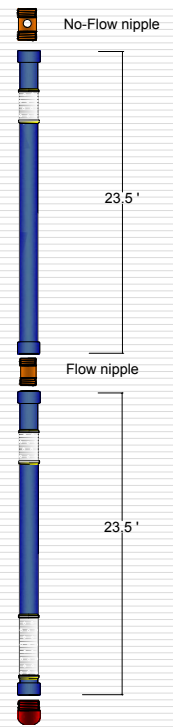
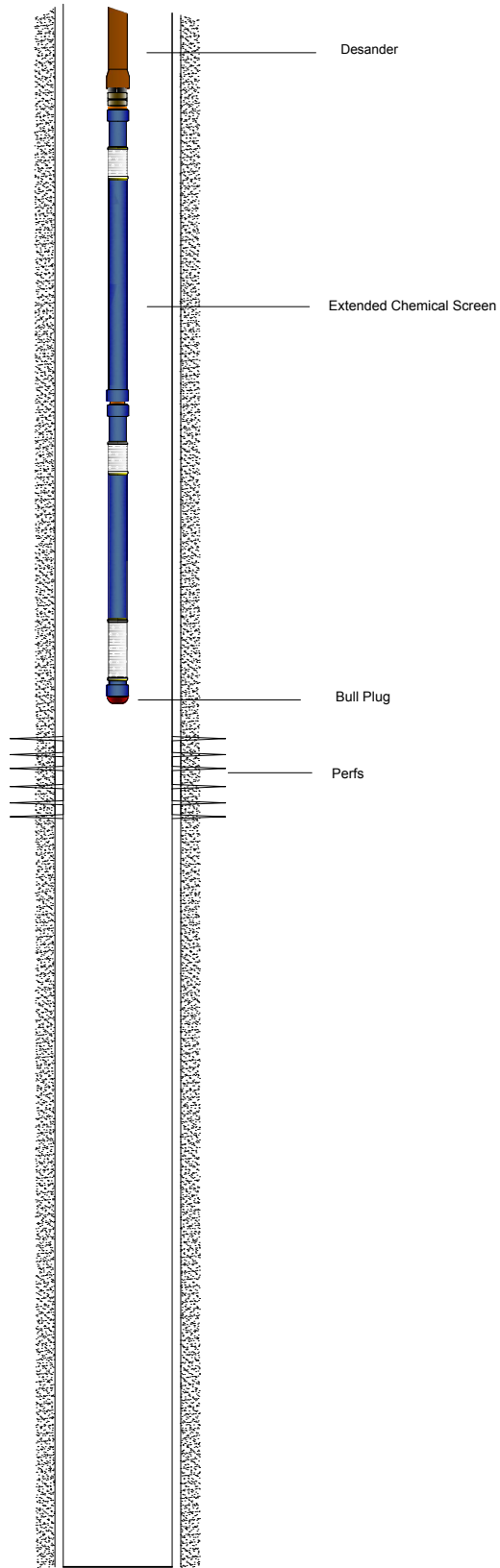

Company:
Field:
Well:

Config. 11.3.2 / SGS W/BODY 48' Dip-Tube - MJ - PS -
ON/OFF Tool - Packer - Desander - EXT. CS



Phone: +1 (432) 580-7111
Fax: +1 (432) 333-2015
1612 Viceroy • Odessa, TX 79763, US
ggonzalez@odessaseparator.com

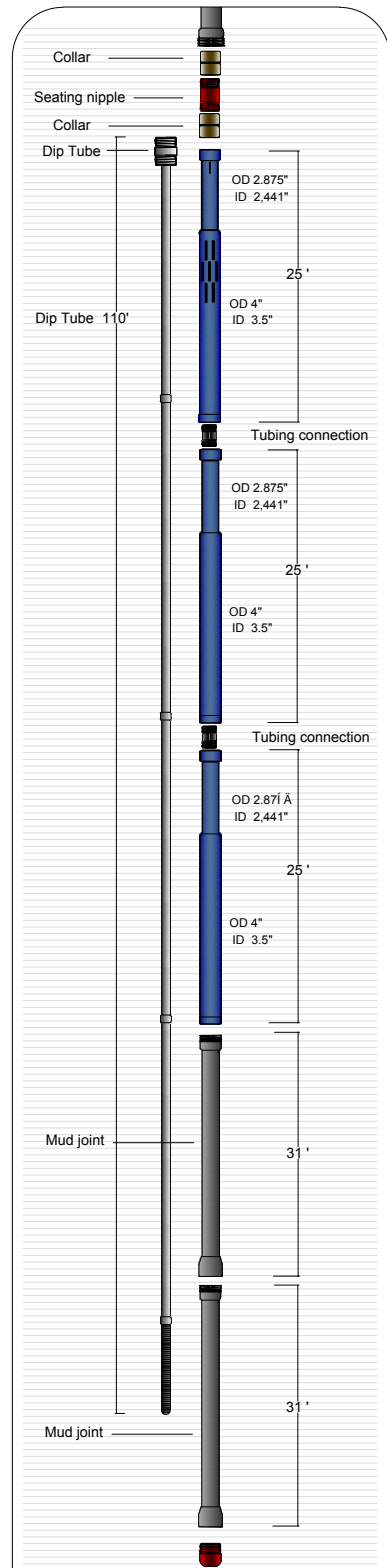
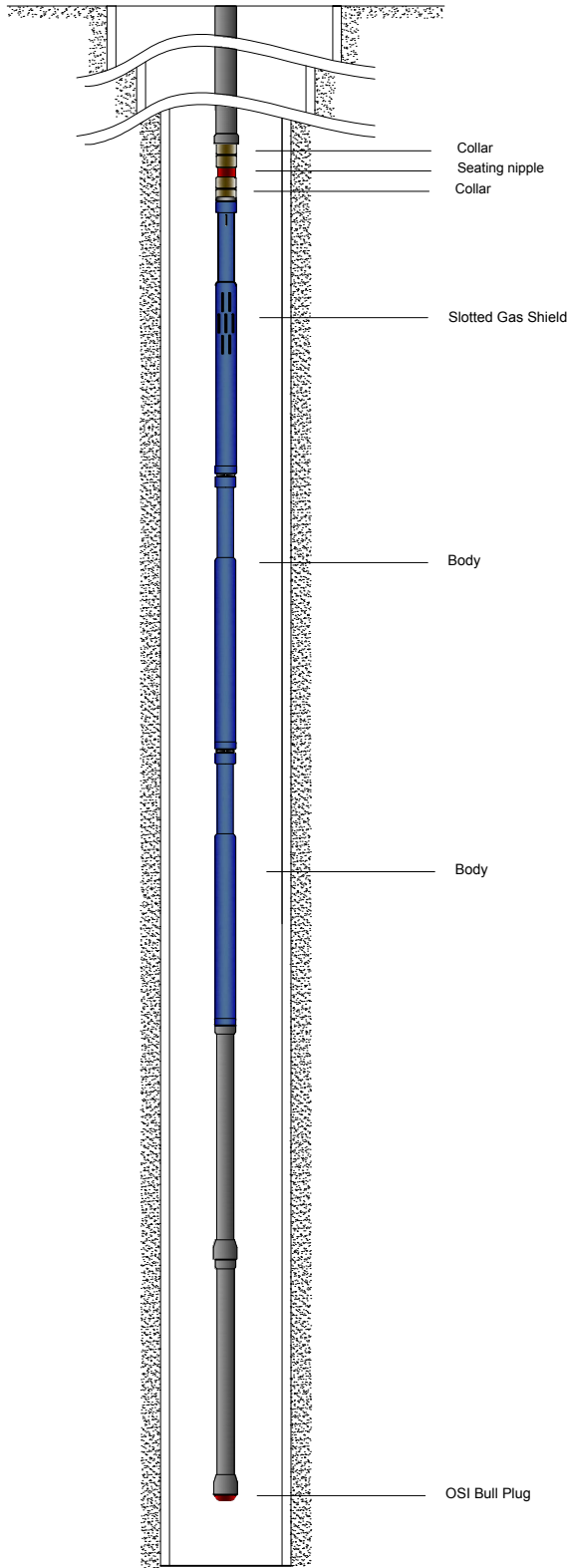

Company:
Field:
Well:

Config. 11.4 / Slotted Gas Shield - (2) Bodies with 110'
Dip-Tube - 2MJ - Bull Plug



Phone: +1 (432) 580-7111
Fax: +1 (432) 333-2015
1612 Viceroy • Odessa, TX 79763, US
ggonzalez@odessaseparator.com

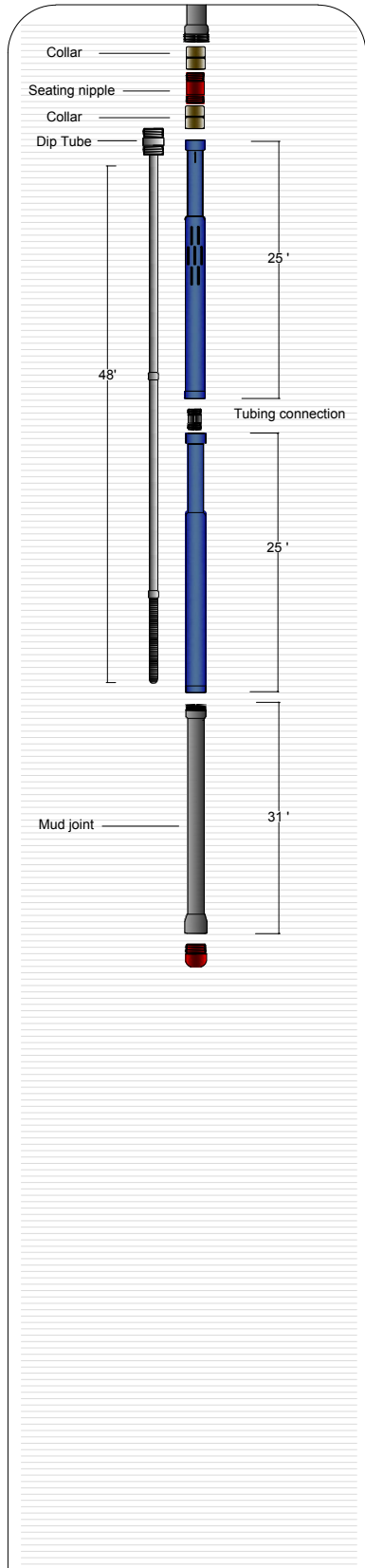
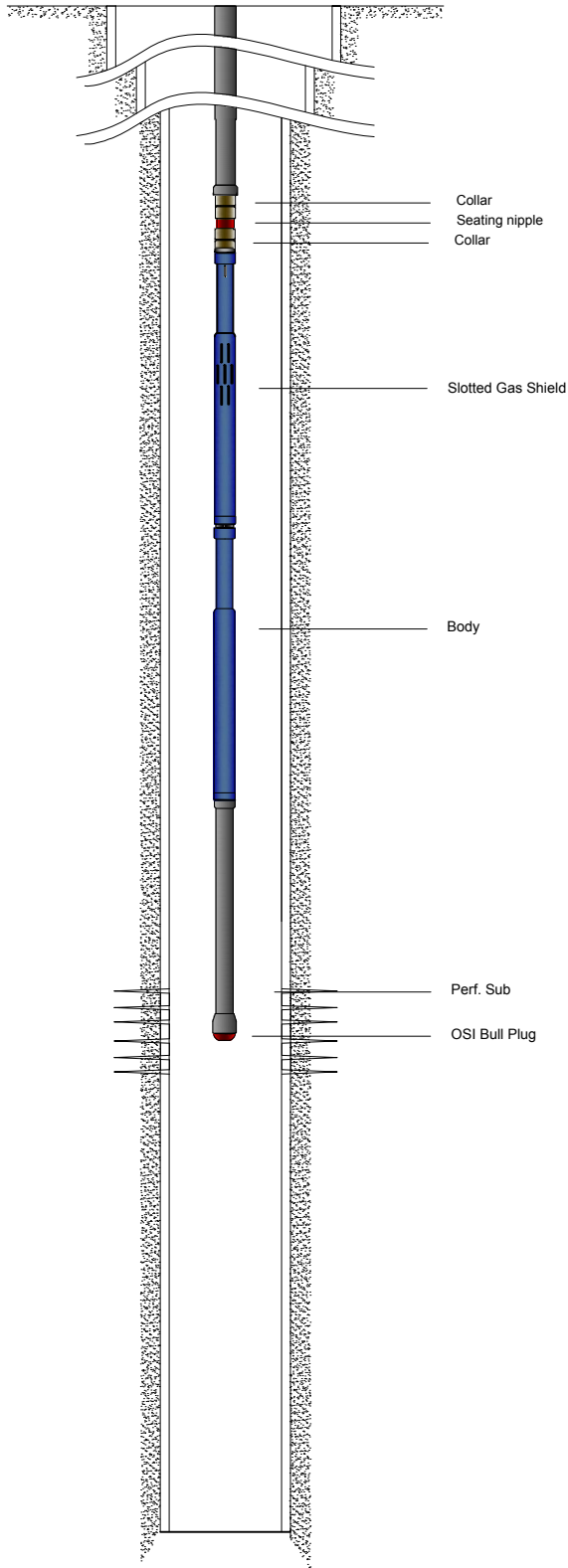

Company:
Field:
Well:

Config. 11.5 / SGS W/BODY 48' Dip-Tube - MJ - OSI Bull Plug



Phone: +1 (432) 580-7111
Fax: +1 (432) 333-2015
1612 Viceroy • Odessa, TX 79763, US
ggonzalez@odessaseparator.com

Assembly Above Packer

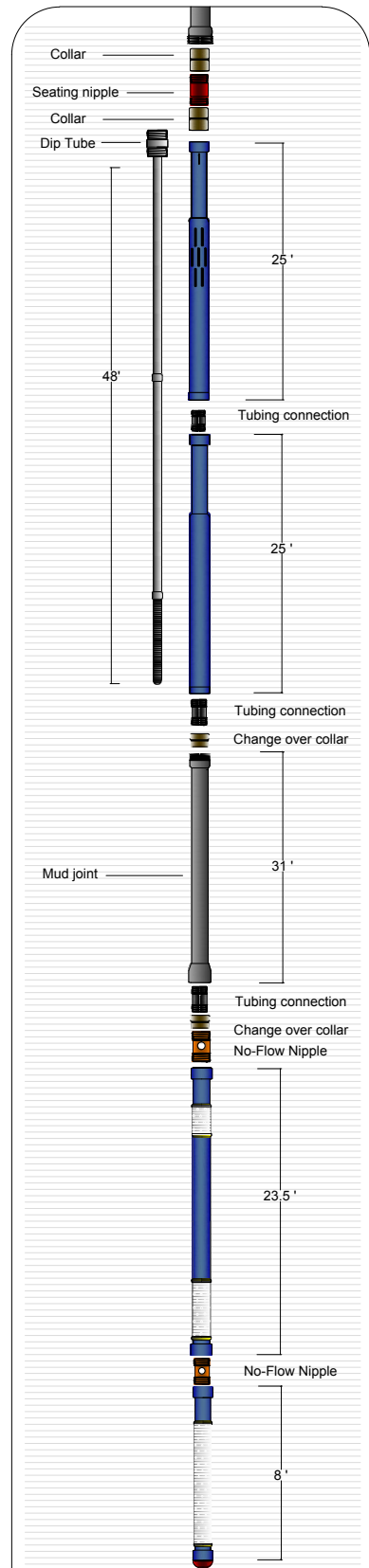
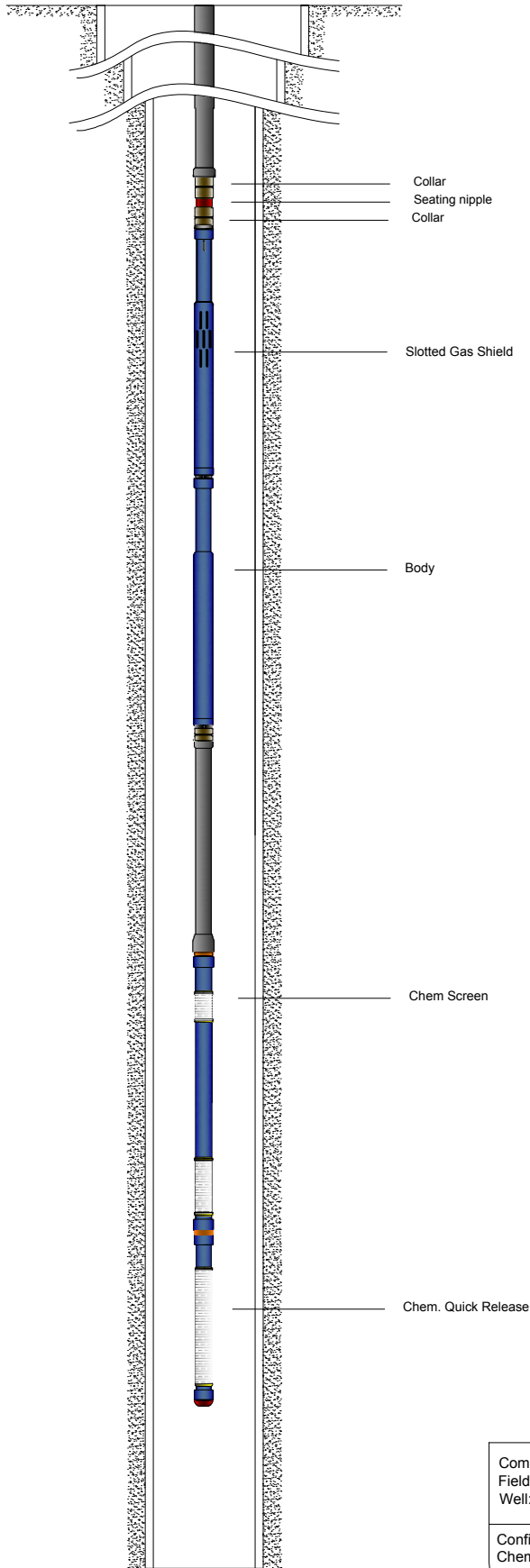

Company:
Field:
Well:

Config. 11.6 / SGS W/BODY 48' Dip-Tube - MJ - CS -
Chem Quick Release



Phone: +1 (432) 580-7111
Fax: +1 (432) 333-2015
1612 Viceroy • Odessa, TX 79763, US
ggonzalez@odessaseparator.com

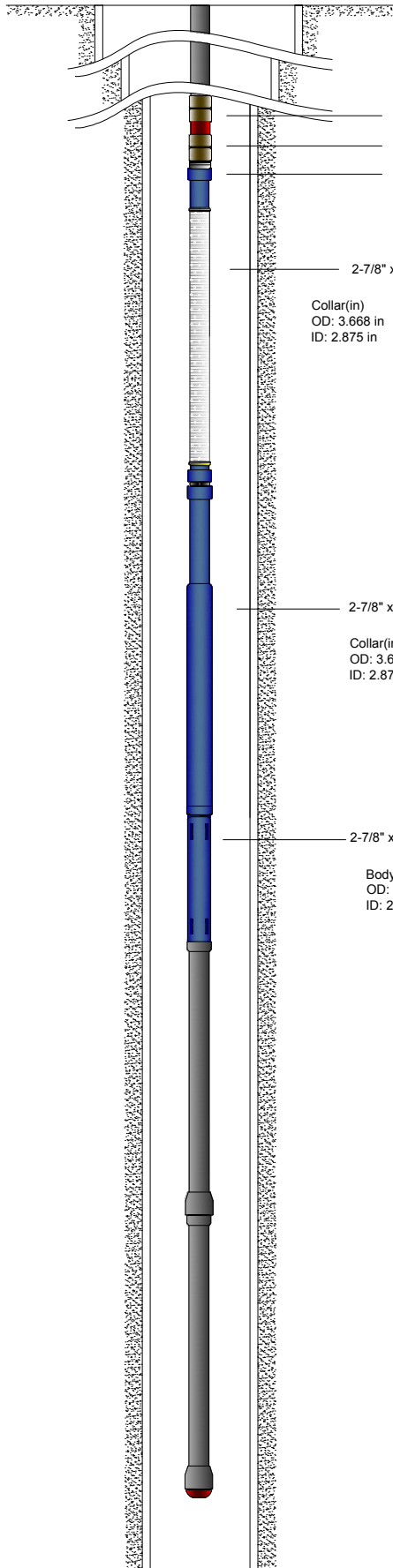

Collar
Seating nipple
Collar

2-7/8" x 23.5' x 20 SlotTubing Screen

Collar(in)	Pipe (in)	Screen (in)	20 SLOT
OD: 3.668 in	OD: 2.875 in	OD: 3.37 in	> 500 Microns
ID: 2.875 in	ID: 2.441 in		

2-7/8" x 4" x 24' Gas Separator Body

Collar(in)	Neck (in)	Body (in)
OD: 3.668 in	OD: 2.875 in	OD: 4.00 in
ID: 2.875 in	ID: 2.441 in	ID: 3.50 in

2-7/8" x 4" w/ H.E 2.5 Vortex Sand Shield

Body (in)	Helix
OD: 2.875 in	HE 2.5
ID: 2.441 in	

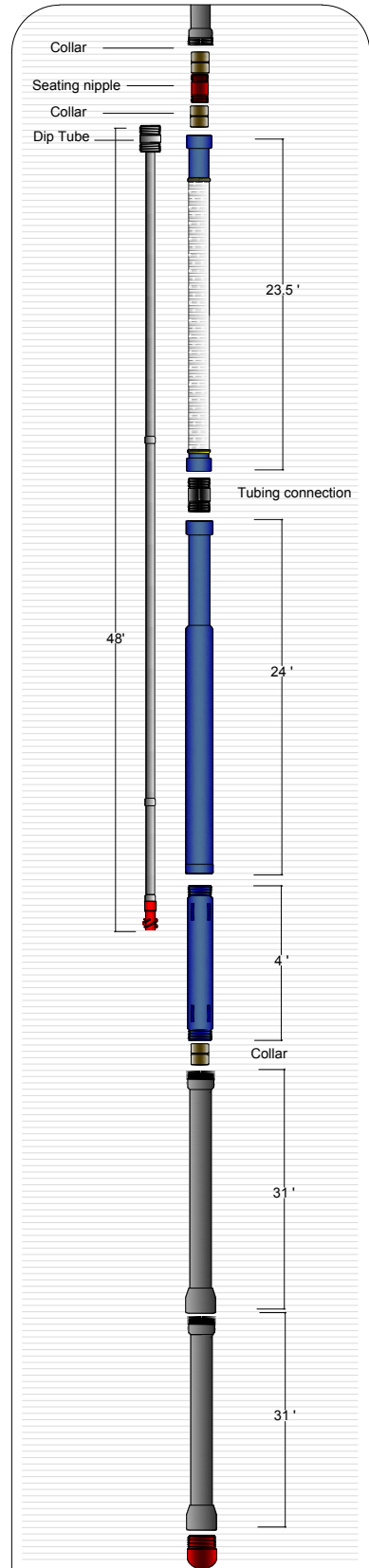

Collar
Seating nipple
Collar
Dip Tube

23.5'

Tubing connection

48'

24'

4'

Collar

31'

31'

Company:
Field:
Well:

Config. 12.7 / Super Gas & Sand Shield with 48 ft - Vortex Sand Shield - 2 Mud joint - Bull Plug.



Phone: +1 (432) 580-7111
Fax: +1 (432) 333-2015
1612 Viceroy • Odessa, TX 79763, US
ggonzalez@odsep.com

Assembly Above Packer

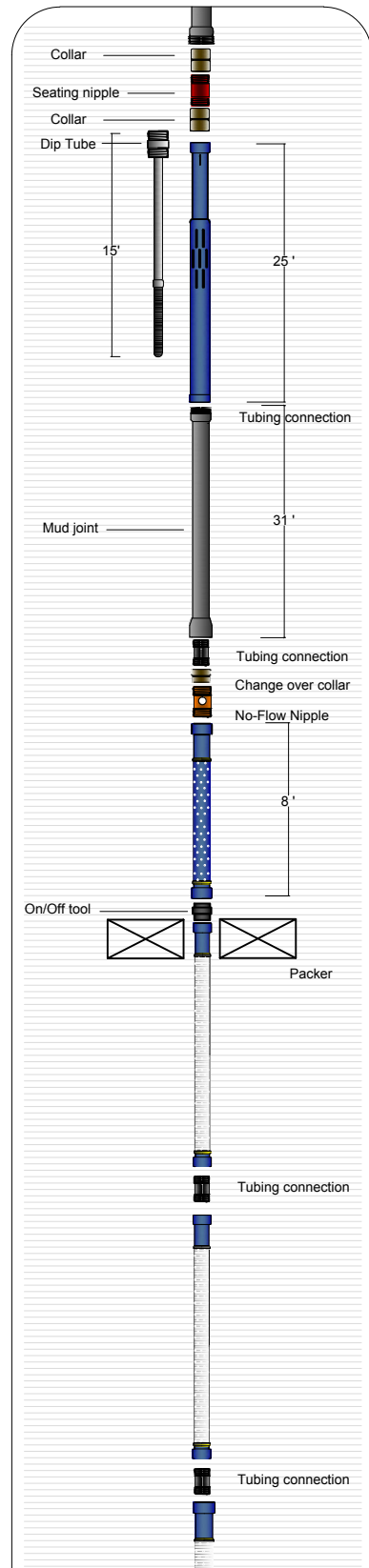
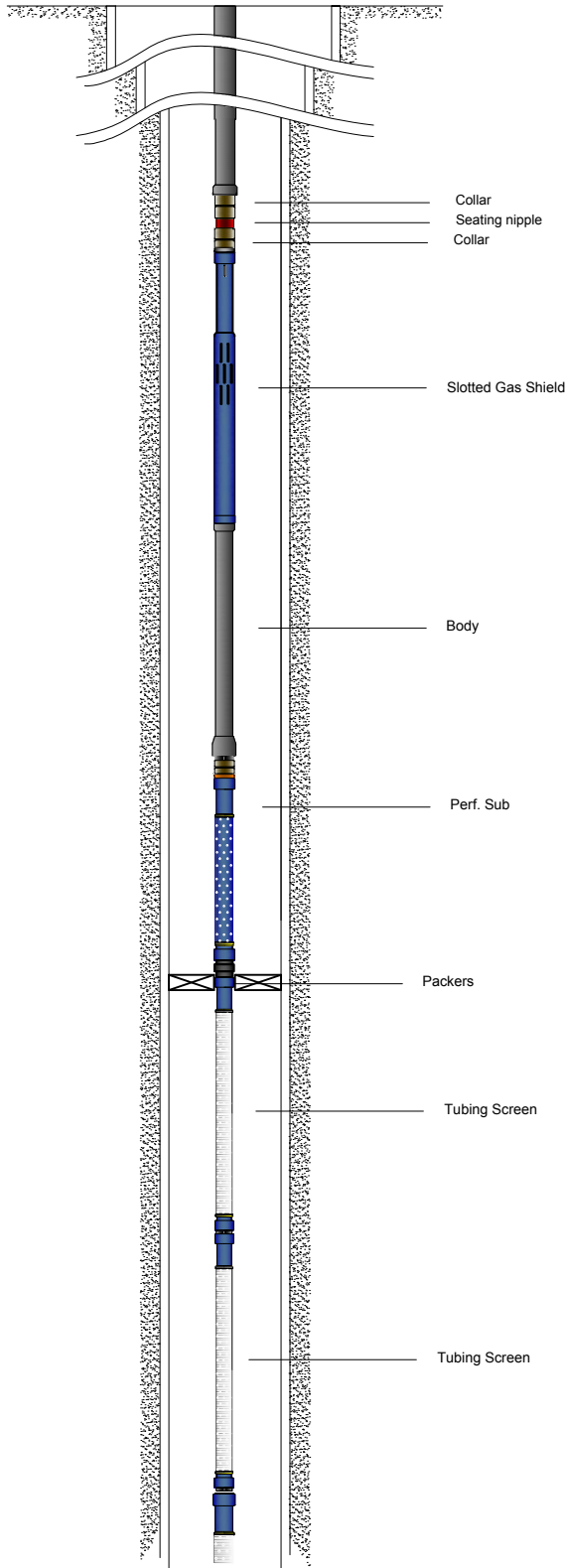

Company:
Field:
Well:

Config. 11.8.1 / SGS 15' Dip-Tube - MJ - PS - ON/OFF
Tool - Packer - 3 Tubing Screens



Phone: +1 (432) 580-7111
Fax: +1 (432) 333-2015
1612 Viceroy • Odessa, TX 79763, US
ggonzalez@odsep.com

Part 2

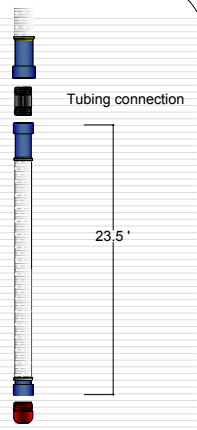
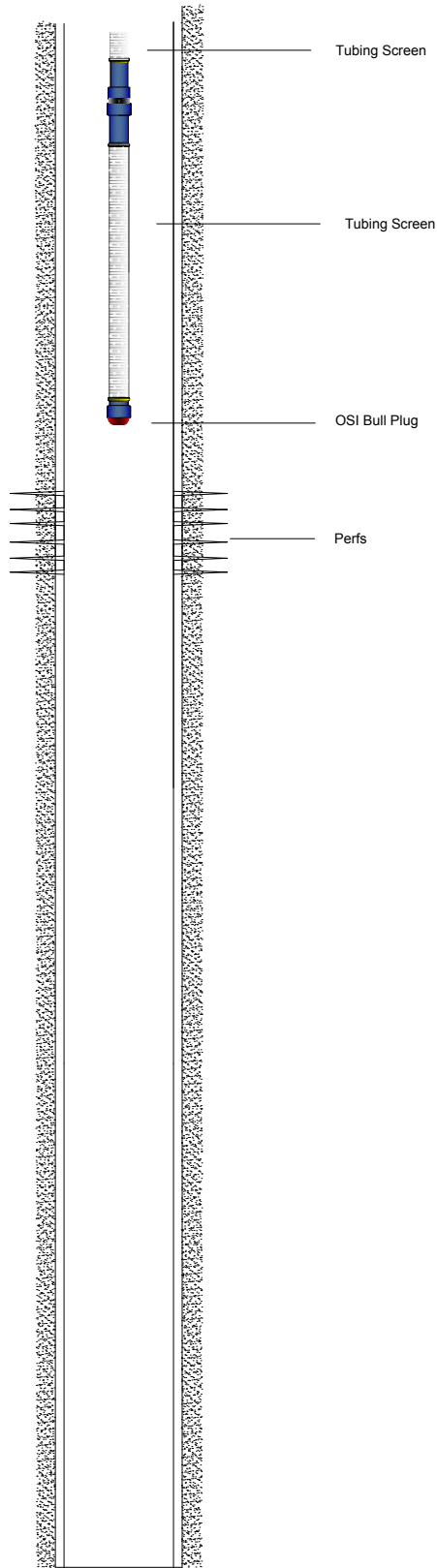

Company:
Field:
Well:

Config. 11.8.2 / SGS 15' Dip-Tube - MJ - PS - ON/OFF
Tool - Packer - 3 Tubing Screens

Phone: +1 (432) 580-7111
Fax: +1 (432) 333-2015
1612 Viceroy • Odessa, TX 79763, US
ggonzalez@odsep.com

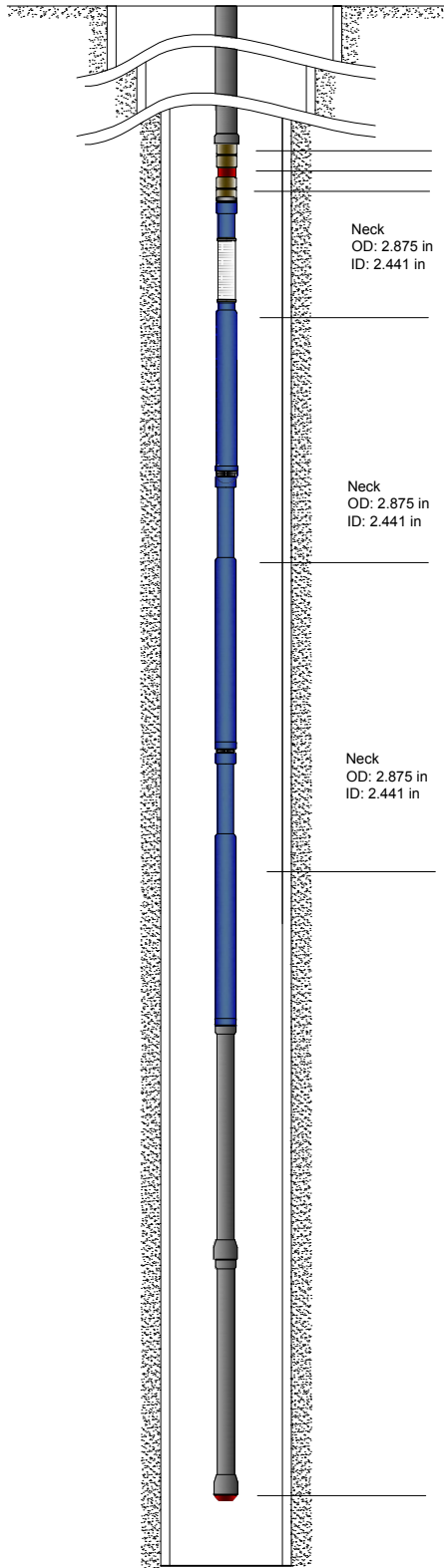

Collar
Seating nipple
Collar

Neck OD: 2.875 in ID: 2.441 in	Body OD: 3.50 in ID: 3.00 in	Collar OD: 3.668 in ID: 2.875 in	Screen OD: 3.37 in
--------------------------------------	------------------------------------	--	-----------------------

Gas Shield 2-7/8" x 24' x 75 slot

Neck OD: 2.875 in ID: 2.441 in	Body OD: 3.50 in ID: 3.00 in	Collar OD: 3.668 in ID: 2.875 in
--------------------------------------	------------------------------------	--

Body

Neck OD: 2.875 in ID: 2.441 in	Body OD: 3.50 in ID: 3.00 in	Collar OD: 3.668 in ID: 2.875 in
--------------------------------------	------------------------------------	--

Body

OSI Bull Plug

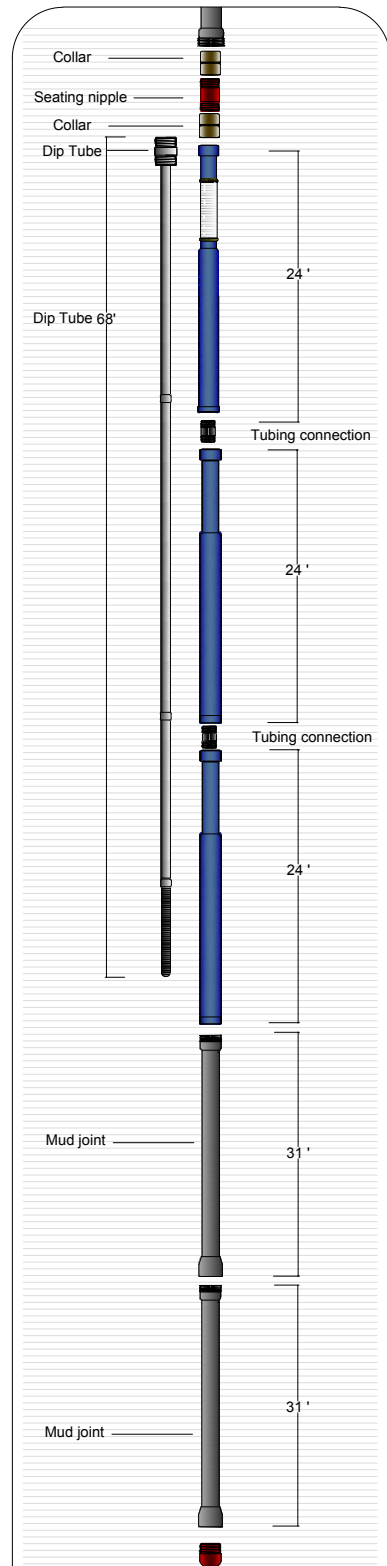

Collar
Seating nipple
Collar
Dip Tube

24'

Dip Tube 68'

Tubing connection

24'

Tubing connection

24'

Mud joint

31'

Mud joint

31'

Company:
Field:
Well:

Config. 11.J / Gas Shield - (2) Bodies with 68' Dip-Tube -
2MJ - Bull Plug



Phone: +1 (432) 580-7111
Fax: +1 (432) 333-2015
1612 Viceroy • Odessa, TX 79763, US
ggonzalez@odsep.com

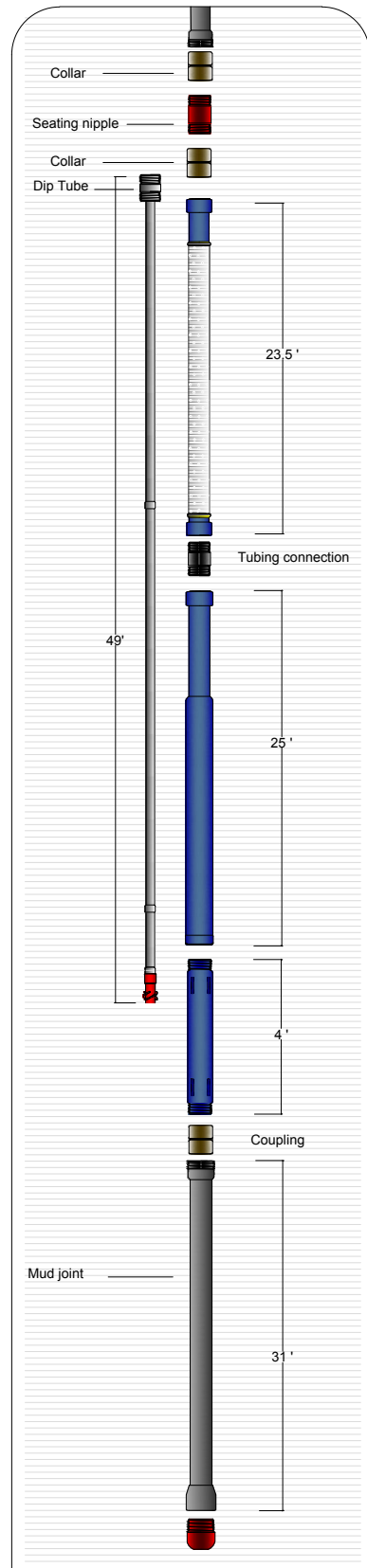
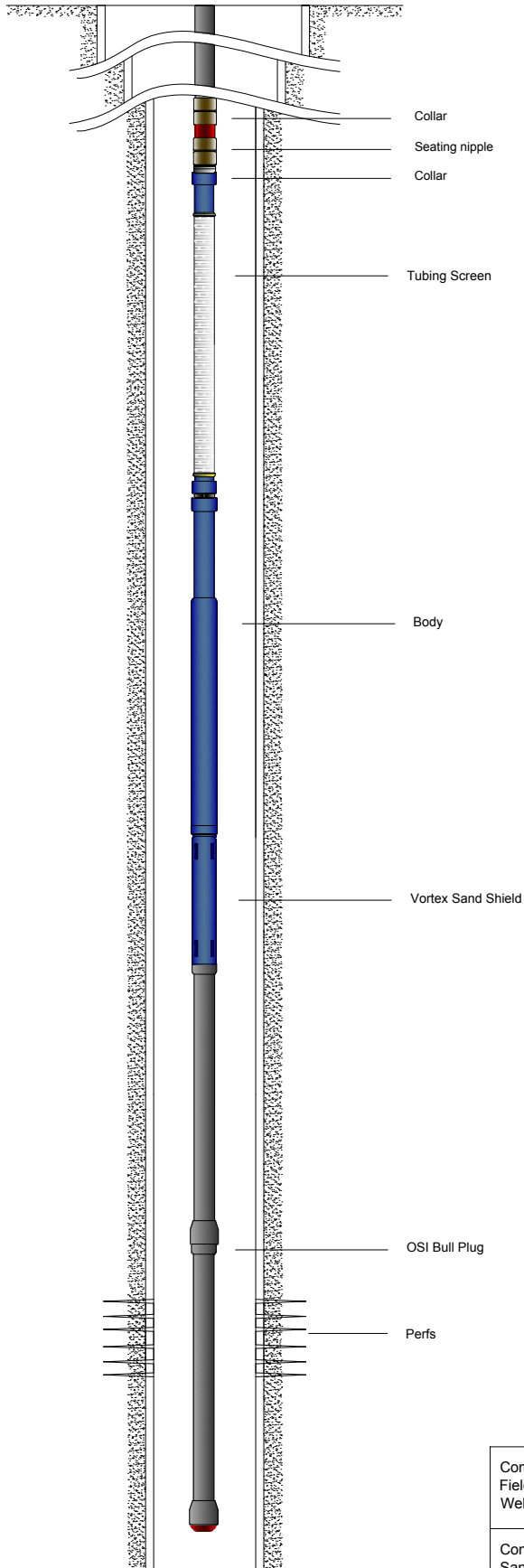

Company:
Field:
Well:

Config. 12.1 / Super Gas & Sand Shield with 49ft - Vortex
Sand Shield - Mud joint



Phone: +1 (432) 580-7111
Fax: +1 (432) 333-2015
1612 Viceroy • Odessa, TX 79763, US
ggonzalez@odsep.com

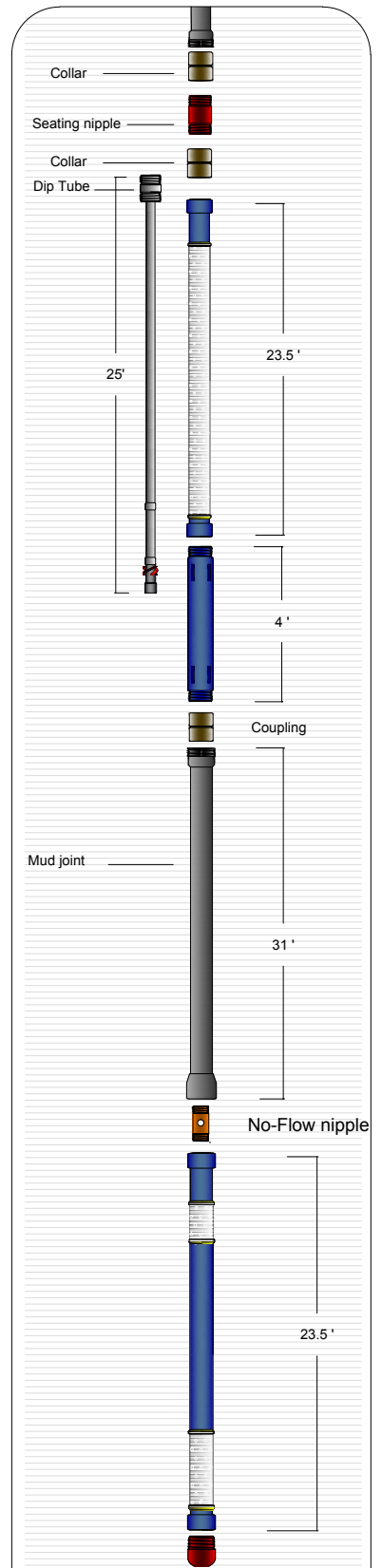
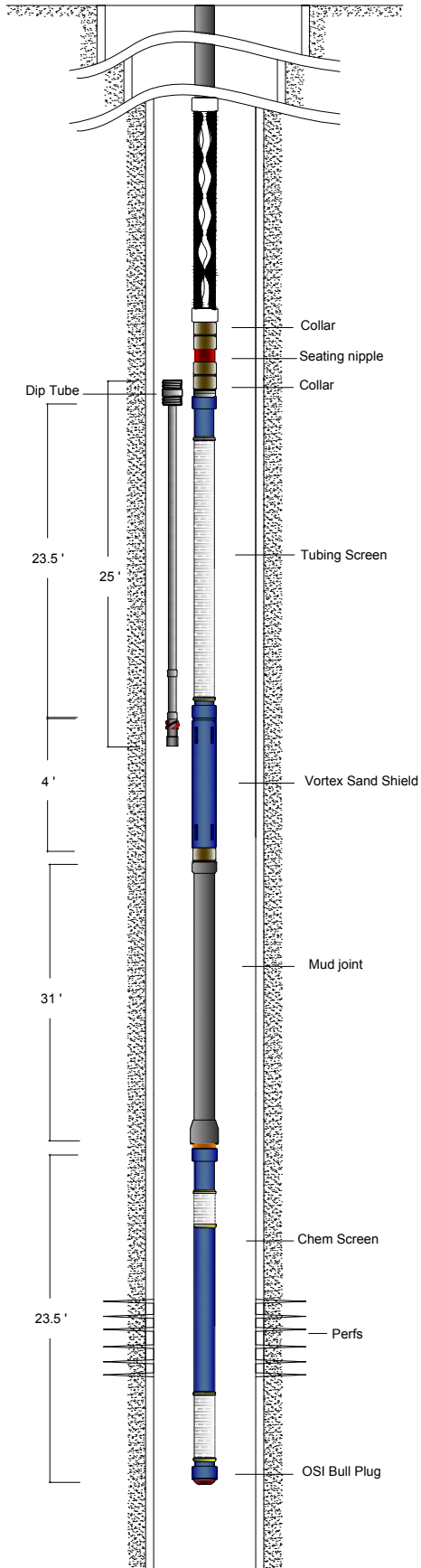

Company:
Field:
Well:

Config. 12.2 / TS with 25 ft - Vortex Sand Shield - Mud joint - Chemical Screen



Phone: +1 (432) 580-7111
Fax: +1 (432) 333-2015
1612 Viceroy • Odessa, TX 79763, US
ggonzalez@odsep.com

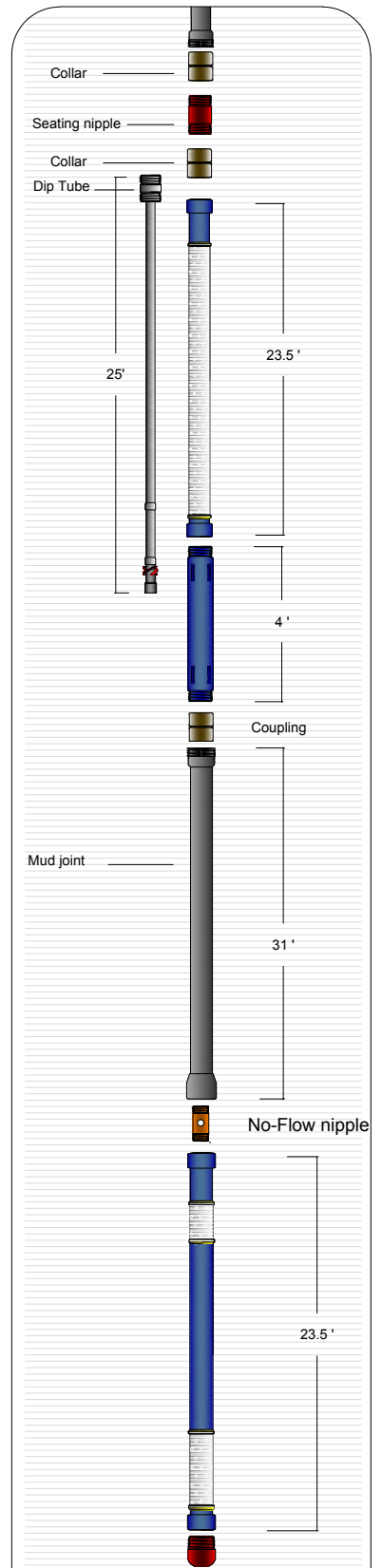
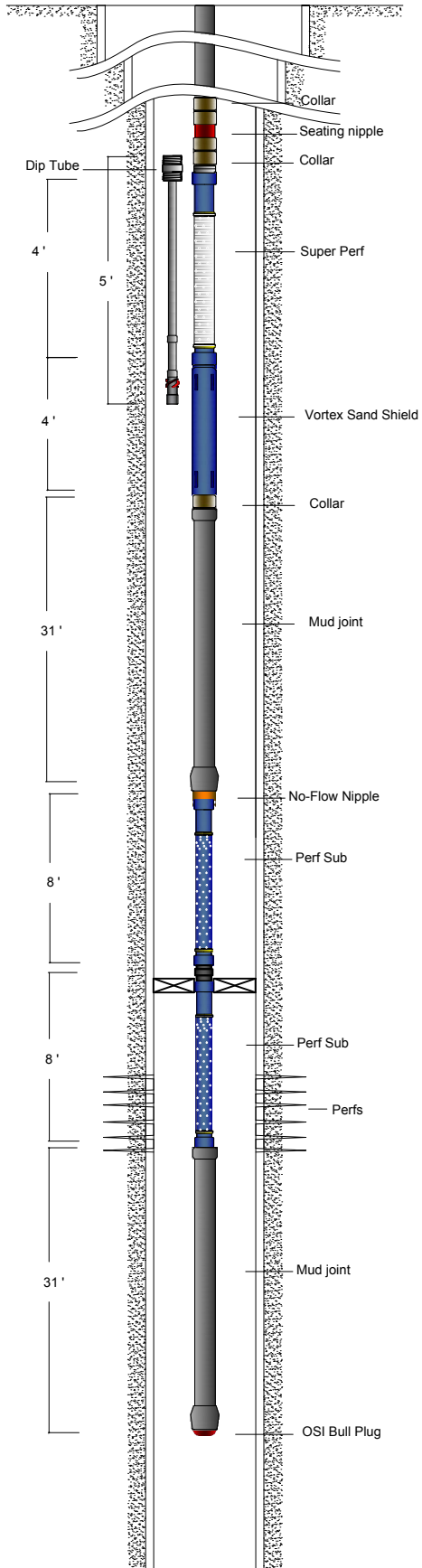

Company:
Field:
Well:

Config. 12.H/ TS with 25 ft - Vortex Sand Shield - Mud joint - Chemical Screen



Phone: +1 (432) 580-7111
Fax: +1 (432) 333-2015
1612 Viceroy • Odessa, TX 79763, US
ggonzalez@odsep.com

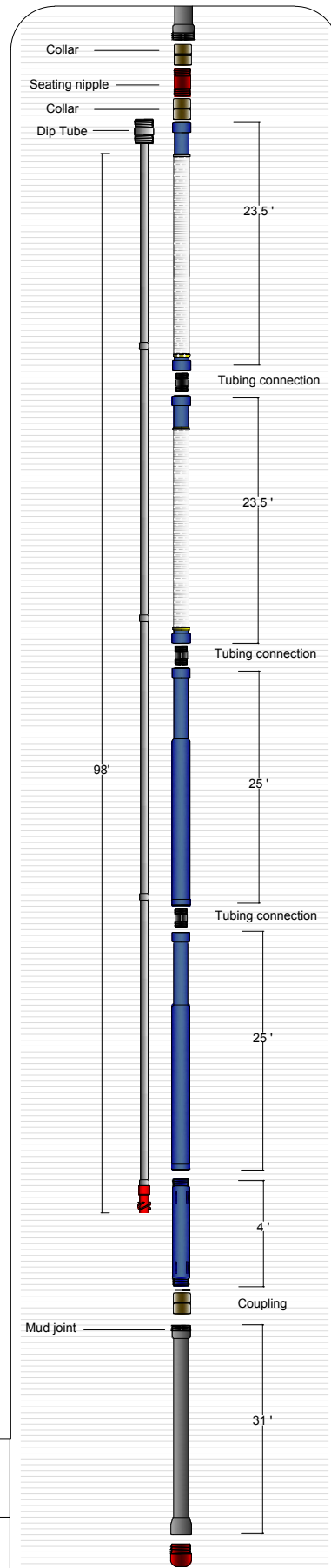
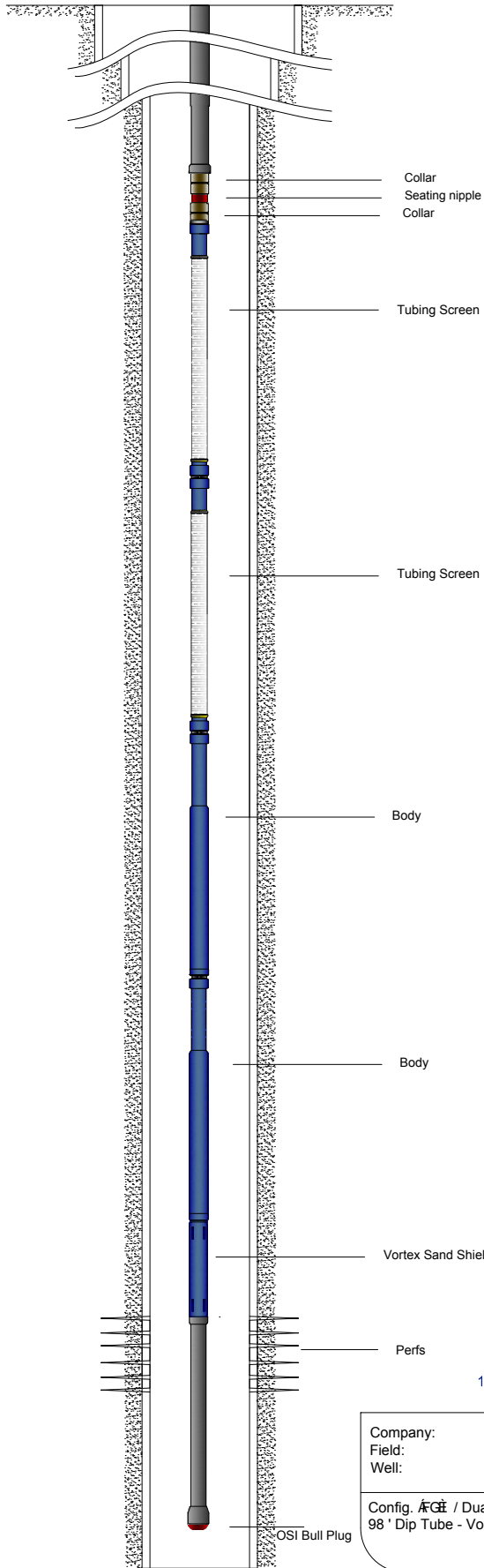

Phone: +1 (432) 580-7111
 Fax: +1 (432) 333-2015
 1612 Viceroy • Odessa, TX 79763, US
ggonzalez@oddsep.com

Company:
 Field:
 Well:

Config. ~~AG~~ / Dual Body Super Gas & Sand Shield with
 98' Dip Tube - Vortex Sand Shield-Mud joint - Bull Plug

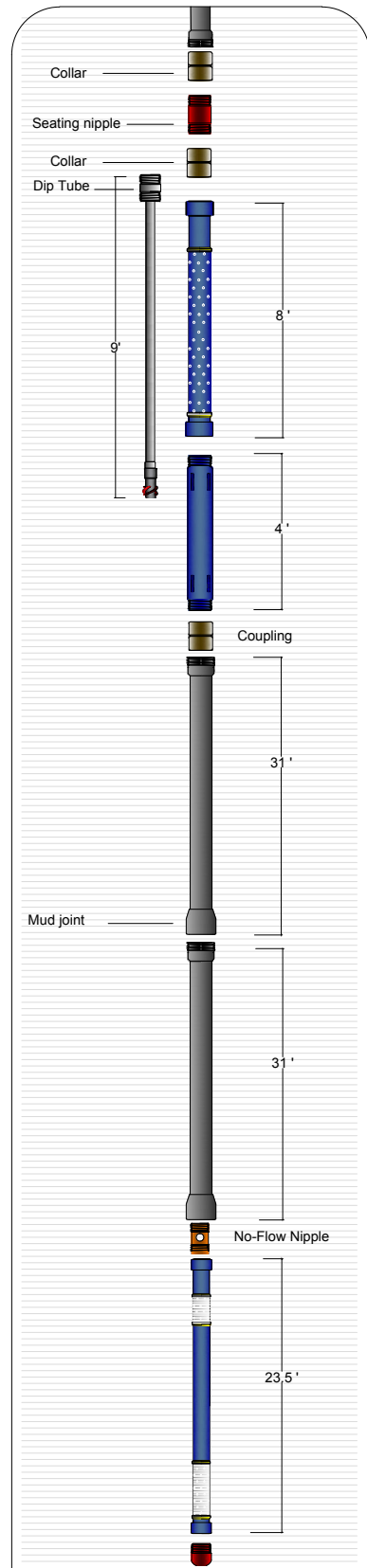
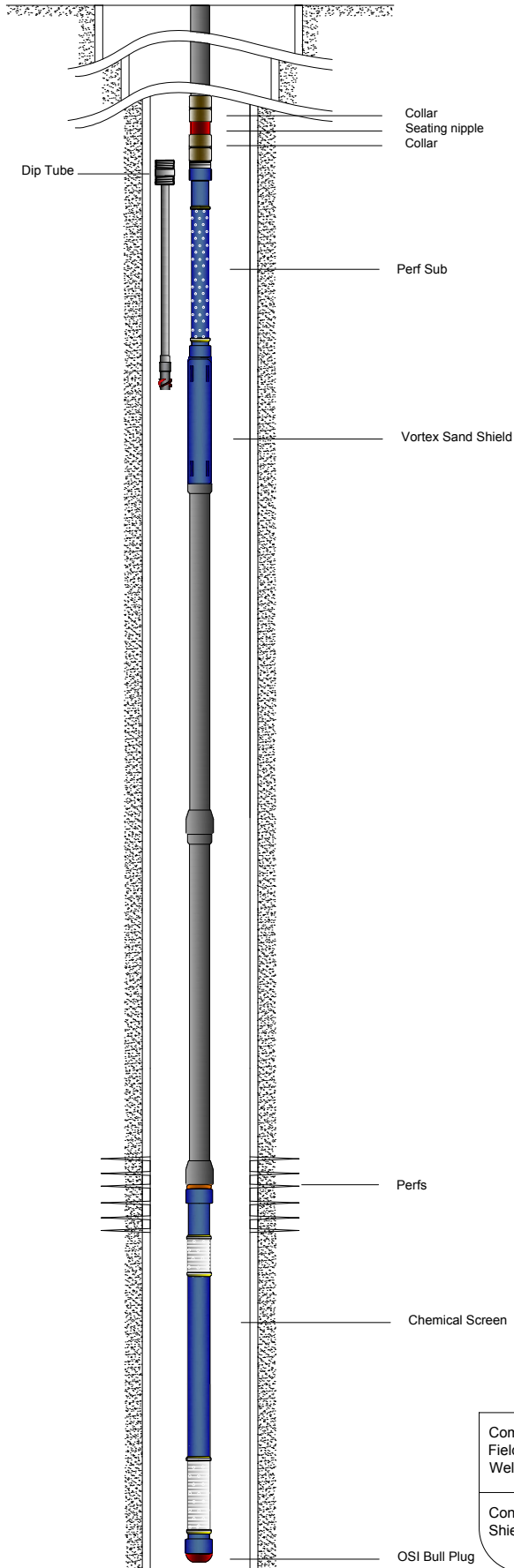

Company:
Field:
Well:

Config. 12.5 / Perf Sub w/ 9 ft Dip Tube- Vortex Sand
Shield - 2 Mud joints - Chem Screen - Bull Plug

OSI Bull Plug



Phone: +1 (432) 580-7111
Fax: +1 (432) 333-2015
1612 Viceroy • Odessa, TX 79763, US
ggonzalez@odsep.com

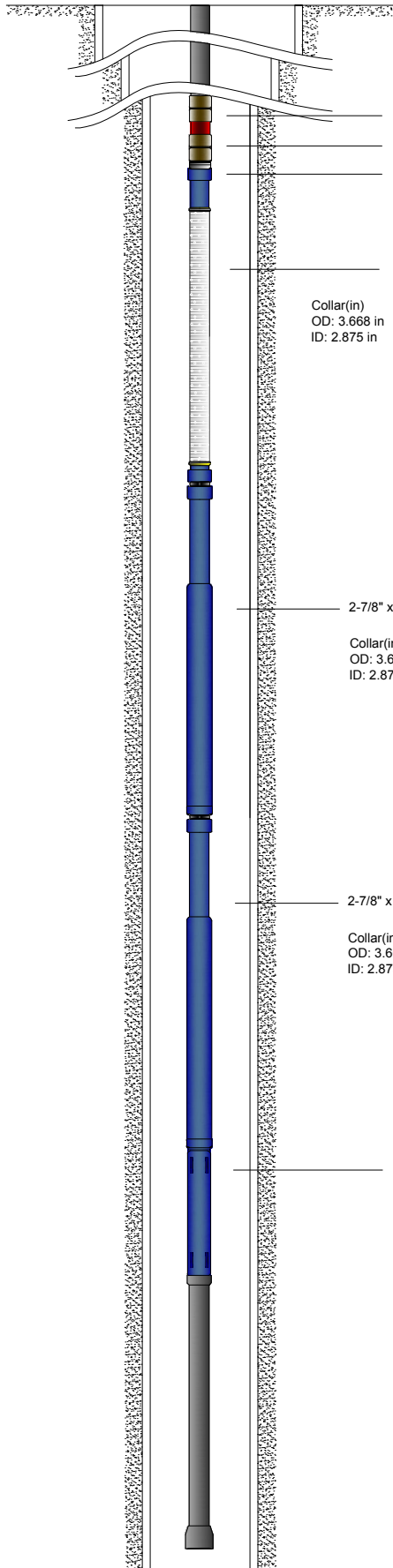

Collar
Seating nipple
Collar

Tubing Screen

Collar (in)	Pipe (in)	Screen (in)
OD: 3.668 in	OD: 2.875 in	OD: 3.37 in
ID: 2.875 in	ID: 2.441 in	

2-7/8" x 3-1/2" x 24' Gas Separator Body

Collar (in)	Neck (in)	Body (in)
OD: 3.668 in	OD: 2.875 in	OD: 3.50 in
ID: 2.875 in	ID: 2.441 in	ID: 3.00 in

2-7/8" x 3-1/2" x 24' Gas Separator Body

Collar (in)	Neck (in)	Body (in)
OD: 3.668 in	OD: 2.875 in	OD: 3.50 in
ID: 2.875 in	ID: 2.441 in	ID: 3.00 in

Vortex Sand Shield

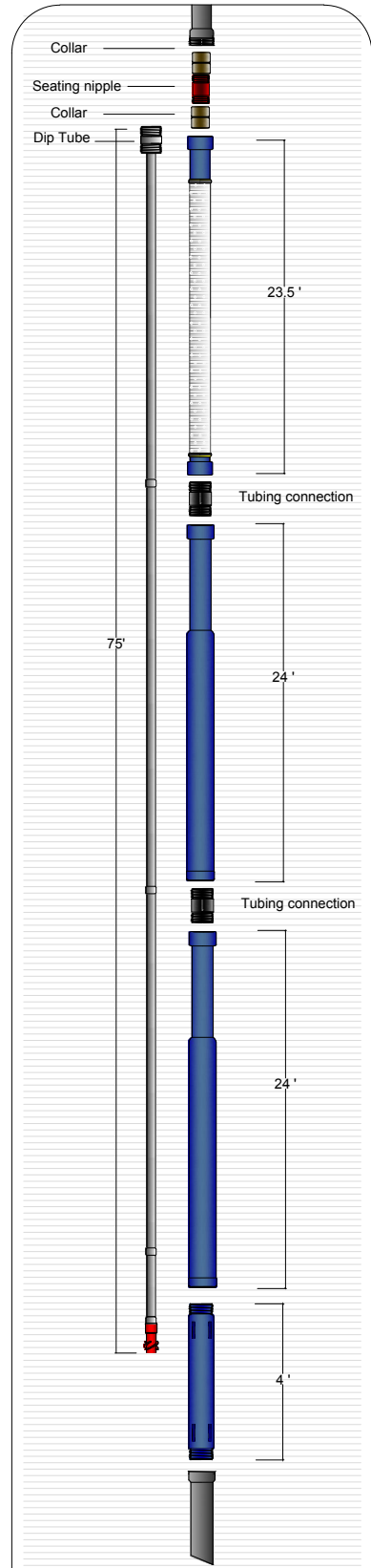

Collar
Seating nipple
Collar
Dip Tube

23.5'

Tubing connection

75'

24'

Tubing connection

24'

4'

Company: Energen
Field:
Well:

Config. 12.6.1 / Super Gas & Sand Shield with 75 ft -
Vortex Sand Shield - 3 Mud joint - Chemical Screen.



Phone: +1 (432) 580-7111
Fax: +1 (432) 333-2015
1612 Viceroy • Odessa, TX 79763, US
ggonzalez@odsep.com

Assembly Below Mud Joint (Page 2)

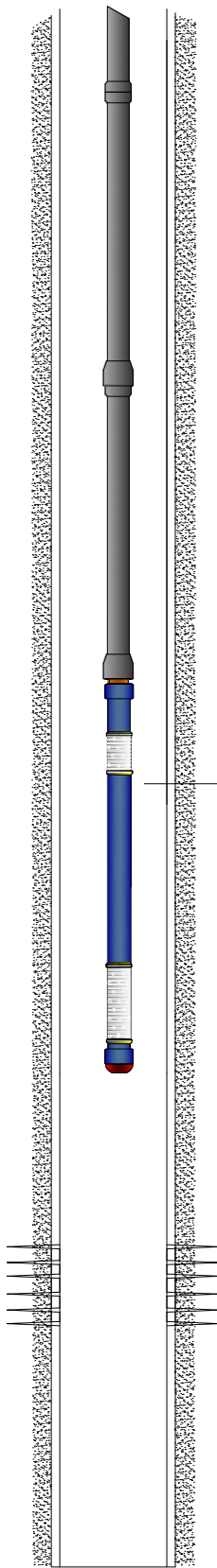

Chemical Screen

Collar (in)	Pipe (in)	Screen (in)
OD: 3.668 in ID: 2.875 in	OD: 2.875 in ID: 2.441 in	OD: 3.37 in

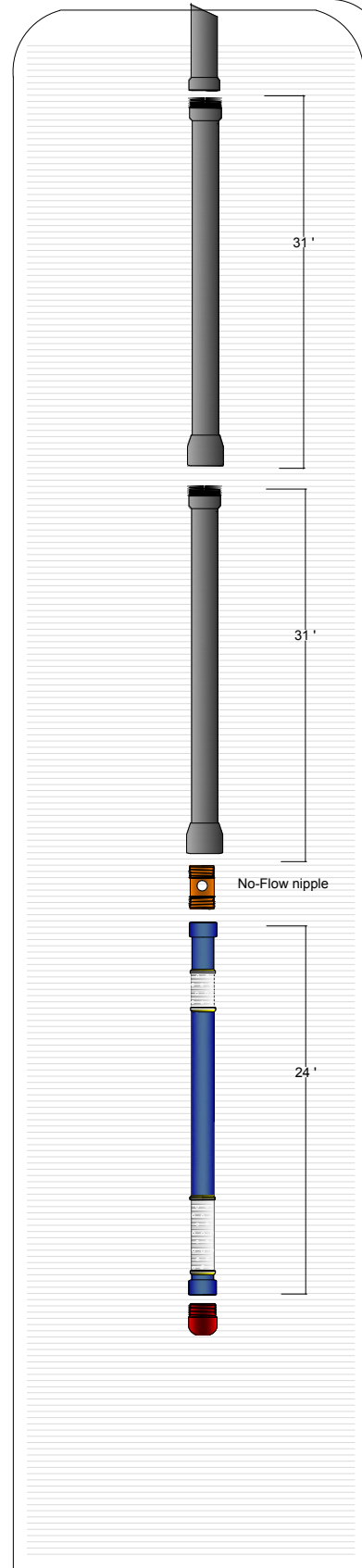

31'

31'

No-Flow nipple

24'

Company: Energen
Field:
Well:

Config. 12.6.2 / Super Gas & Sand Shield with 75 ft -
Vortex Sand Shield - 3 Mud joint - Chemical Screen.



Phone: +1 (432) 580-7111
Fax: +1 (432) 333-2015
1612 Viceroy • Odessa, TX 79763, US
ggonzalez@odsep.com

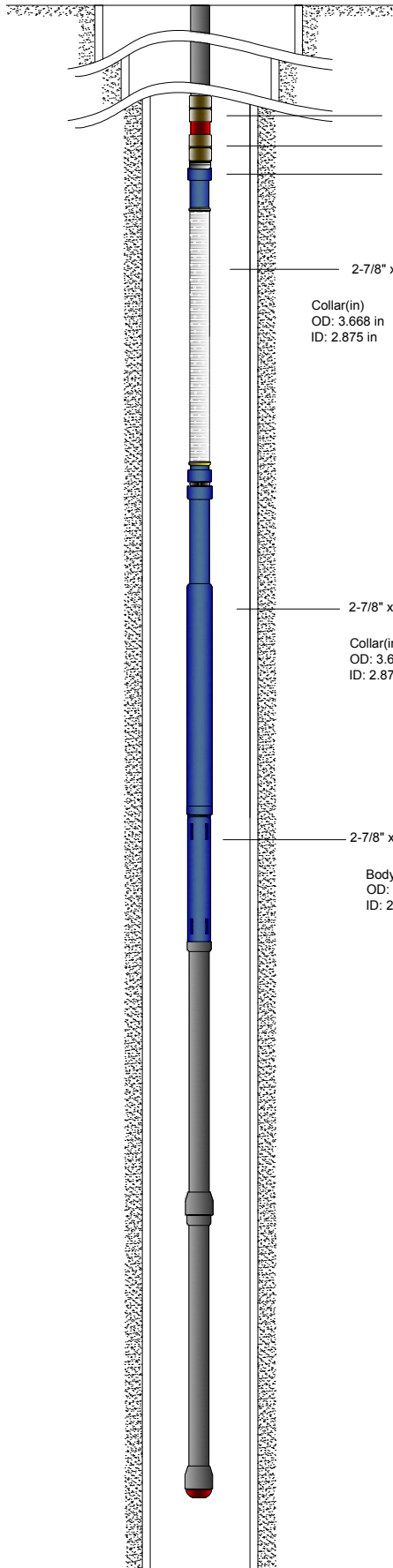

2-7/8" x 23.5' x 20 Slot Tubing Screen

Collar (in)	Pipe (in)	Screen (in)	20 SLOT
OD: 3.668 in	OD: 2.875 in	OD: 3.37 in	> 500 Microns
ID: 2.875 in	ID: 2.441 in		

2-7/8" x 4" x 24' Gas Separator Body

Collar (in)	Neck (in)	Body (in)
OD: 3.668 in	OD: 2.875 in	OD: 4.00 in
ID: 2.875 in	ID: 2.441 in	ID: 3.50 in

2-7/8" x 4" w/ H.E 2.5 Vortex Sand Shield

Body (in)	Helix
OD: 2.875 in	HE 2.5
ID: 2.441 in	

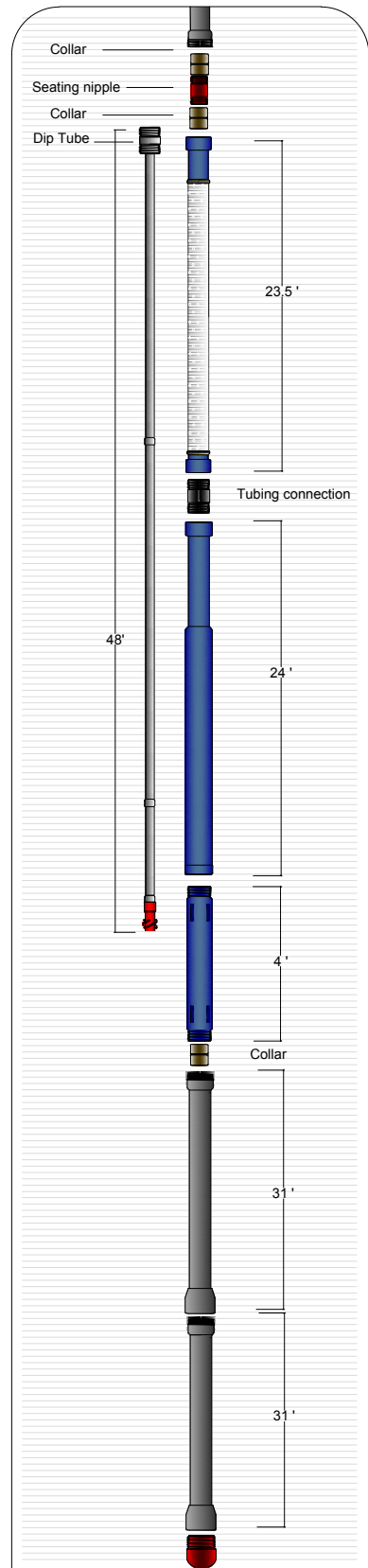

Company:
Field:
Well:

Config. 12.7 / Super Gas & Sand Shield with 48 ft - Vortex Sand Shield - 2 Mud joint - Bull Plug.



Phone: +1 (432) 580-7111
Fax: +1 (432) 333-2015
1612 Viceroy • Odessa, TX 79763, US
ggonzalez@odsep.com

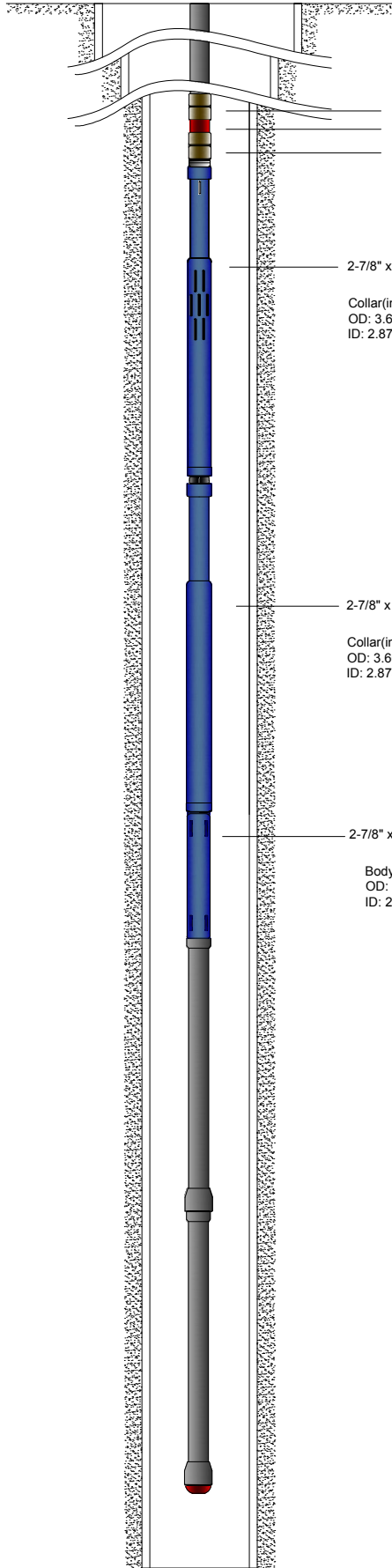

Collar
Seating nipple
Collar

2-7/8" x 4" x 24' Slotted Gas Shield

Collar (in)	Neck (in)	Body (in)
OD: 3.668 in	OD: 2.875 in	OD: 4.00 in
ID: 2.875 in	ID: 2.441 in	ID: 3.50 in

2-7/8" x 4" x 24' Gas Separator Body

Collar (in)	Neck (in)	Body (in)
OD: 3.668 in	OD: 2.875 in	OD: 4.00 in
ID: 2.875 in	ID: 2.441 in	ID: 3.50 in

2-7/8" x 4" w/ H.E 2.5 Vortex Sand Shield

Body (in)	Helix
OD: 2.875 in	HE 2.5
ID: 2.441 in	

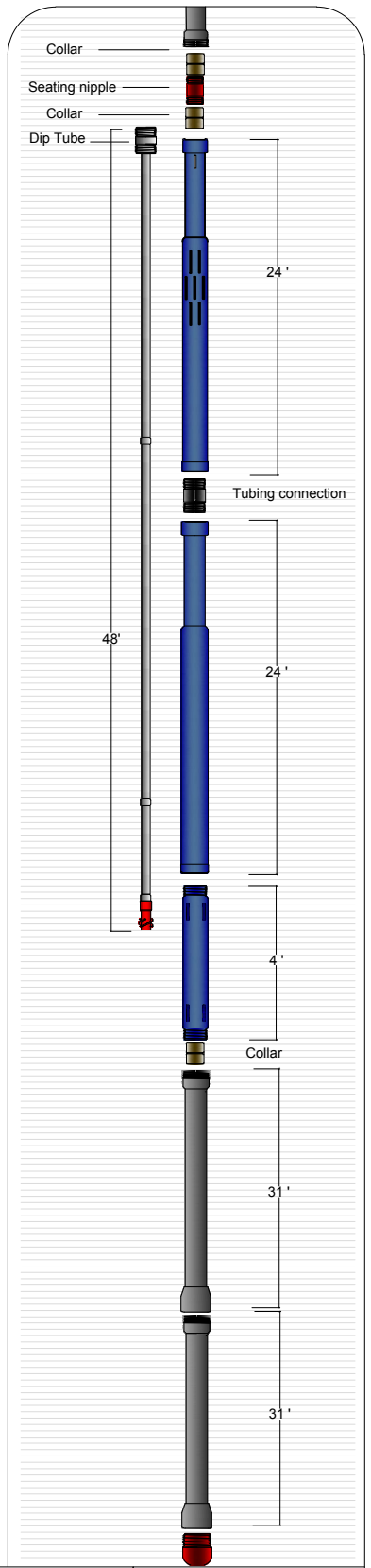

Collar
Seating nipple
Collar
Dip Tube

24'

Tubing connection

48'

24'

4'

Collar

31'

31'

Company:
Field:
Well:

Config. 12.8 / Slotted Gas Shield with 48 ft - Vortex Sand Shield - 2 Mud joint - Bull Plug.

ODESSA
SEPARATOR, INC.

Phone: +1 (432) 580-7111
Fax: +1 (432) 333-2015
1612 Viceroy • Odessa, TX 79763, US
ggonzalez@odsep.com

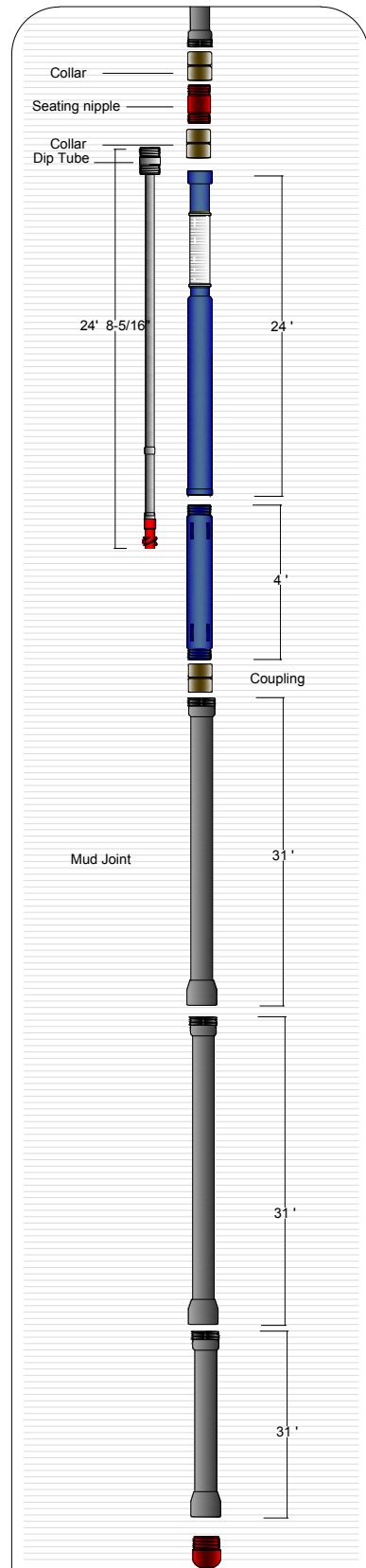
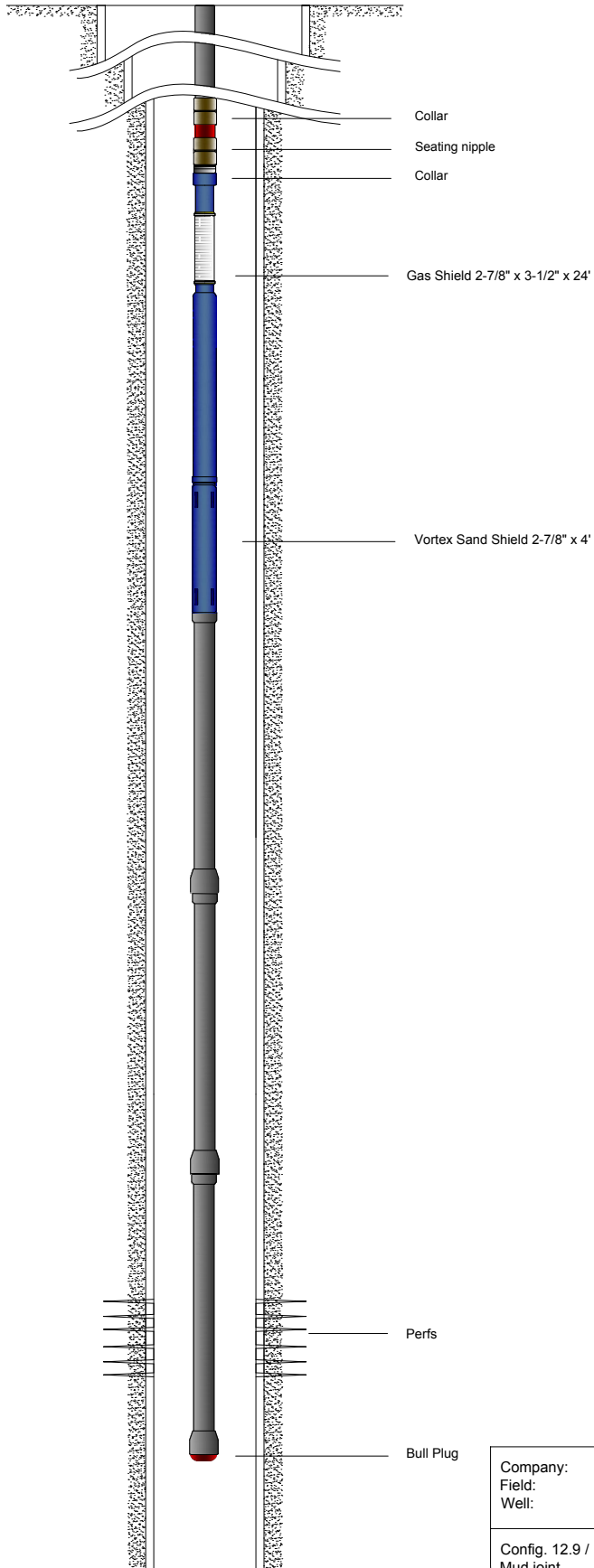

Company:
Field:
Well:

Config. 12.9 / Gas Shield with 24 ft - Vortex Sand Shield -
Mud joint



Phone: +1 (432) 580-7111
Fax: +1 (432) 333-2015
1612 Viceroy • Odessa, TX 79763, US
ggonzalez@odsep.com

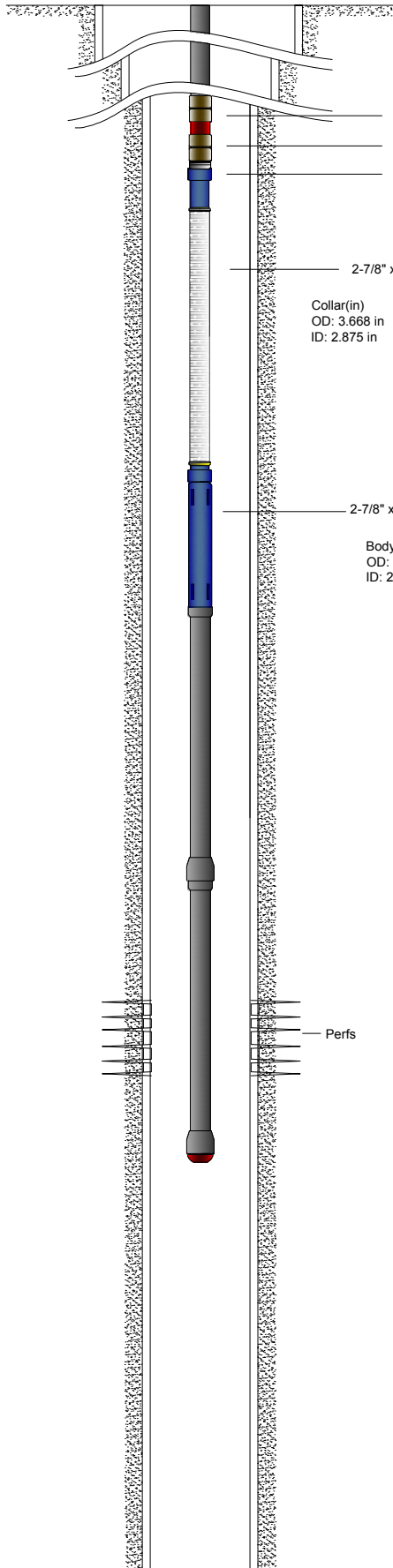

Collar
Seating nipple
Collar

2-7/8" x 23.5' x 30 or 50 Slot Tubing Screen

Collar(in)	Pipe (in)	Screen (in)	20 SLOT
OD: 3.668 in	OD: 2.875 in	OD: 3.37 in	> 500 Microns
ID: 2.875 in	ID: 2.441 in		

2-7/8" x 4' Vortex Sand Shield

Body (in)	< 500 Microns
OD: 2.875 in	
ID: 2.441 in	

Perfs

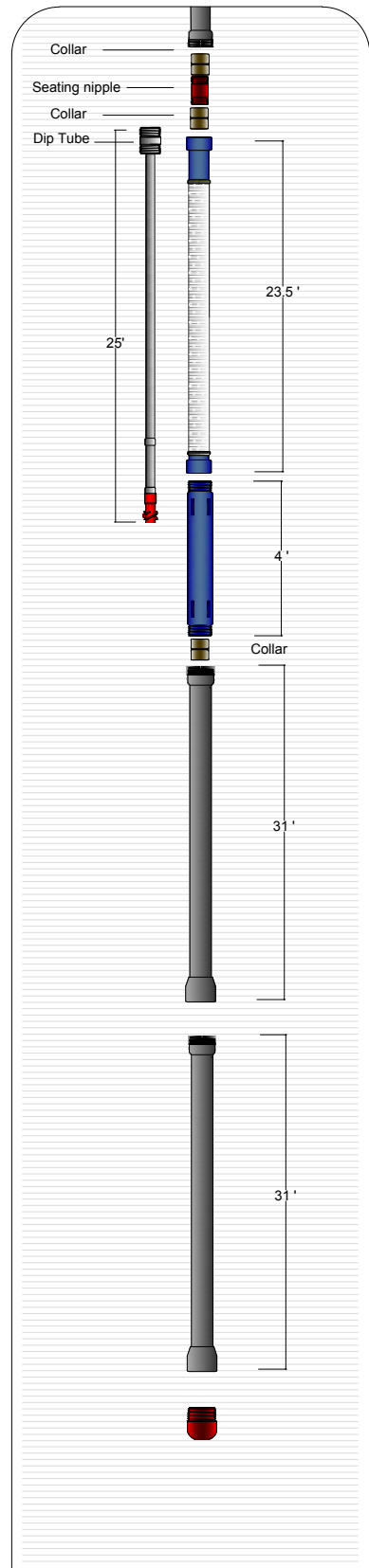

Collar
Seating nipple
Collar
Dip Tube

23.5'

25'

4'

Collar

31'

31'

Company:
Field:
Well:

Config. 12.10 / TS w/ 25 ft Dip Tube - Vortex Sand Shield -
2 Mud joint - Bull Plug.

ODESSA
SEPARATOR, INC.

Phone: +1 (432) 580-7111
Fax: +1 (432) 333-2015
1612 Viceroy • Odessa, TX 79763, US
ggonzalez@odsep.com

Technical Specification

Filtration / Sand Control

Sizes	Pipe (in)		Screen (in)	Collar (in)	
	OD	ID	OD	OD	ID
2-3/8"	2.375	1.941	2.87	3.063	2.375
2-7/8"	2.875	2.441	3.37	3.668	2.875
3-1/2"	3.5	3.066	3.94	4.5	3.5

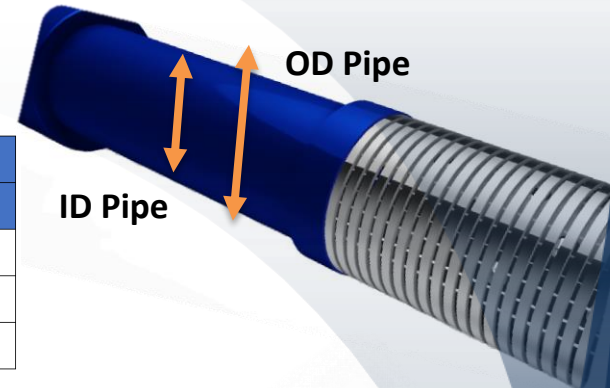

Gas separation

Sizes	Neck (in)		Body (in)		Collar (in)	
	OD	ID	OD	ID	OD	ID
2-3/8" x 3"	2.375	1.941	3	2.5	3.063	2.375
2-7/8" x 3-1/2"	2.875	2.441	3.5	3	3.668	2.875
2-7/8" x 4"	2.875	2.441	4	3.5	3.668	2.875
2-7/8" x 4-1/2"	2.875	2.441	4.5	4	3.668	2.875
3-1/2" x 4-1/2"	3.5	3.066	4.5	4	4.5	3.5
3-1/2" x 5-1/2"	3.5	3.066	5	4.5	4.5	3.5

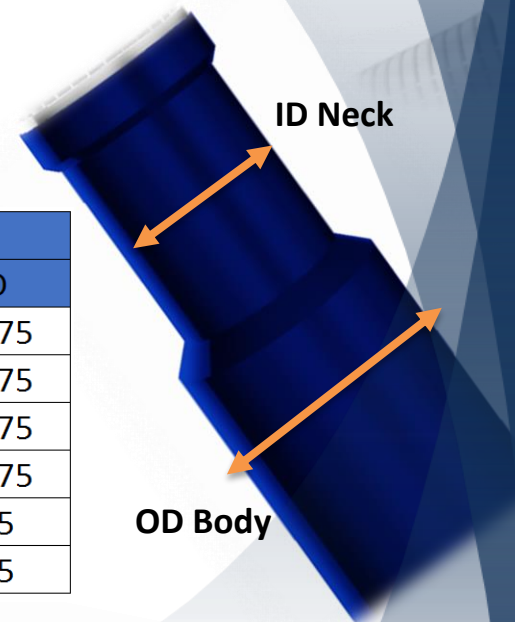

Chemical Treatment

Sizes	Pipe (in)		Screen (in)	Collar (in)	
	OD	ID	OD	OD	ID
2-3/8"	2.375	1.941	2.87	3.063	2.375
2-7/8"	2.875	2.441	3.37	3.668	2.875

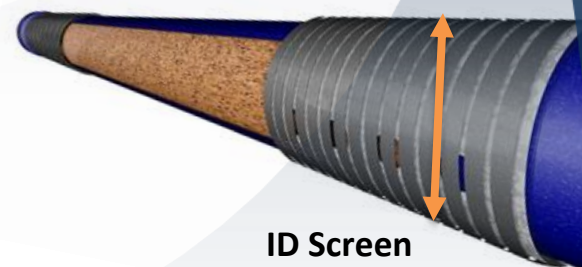



ODESSA
SEPARATOR, INC

1612 S. Viceroy Ave.
Odessa, TX 79763 (USA)
Office: +1(432)-580-7111
www.odessaseparator.com